



# ÜRÜN KATALOĐU









 **AKIN ZİRAAT**

**2025**



# SATIŞ KOŞULLARI

- Fiyatlarımıza KDV dahildir. KDV oranı ürün cinsine göre değişiklik gösterebilir. Resmi kurumlar tarafından yapılan vergi oranları ve benzeri değişiklikler fiyatlara aynen yansıtılacaktır.
- Döviz cinsinden fiyatlandırılmış ürünler, B2B portalımızda belirlenen döviz kuru üzerinden Türk Lirası olarak fatura edilir.
- Sipariş verirken ürünlerin en az sipariş adetlerini göz önünde bulundurmanız gerektiğini hatırlatır ve bu uygulamayı anlayışla karşılayacağınızı umarız.
- Akın Ziraat, fiyatlarını önceden haber vermeksizin değiştirme hakkına sahiptir.
- AKIN ZİRAAT, katalogta baskı hataları olabileceğini kabul eder, fakat bununla alakalı herhangi bir sorumluluk kabul etmez.
- Sipariş edilen ürünler, D-100 Karayolu üzeri DSI yanı No: 432 Düzce adresinden teslim edilir. Sevkiyatlar, müşterinin portal üzerinden seçtiği şekilde yapılır.
- Her türlü taşıma ücreti ve taşıma sırasında oluşabilecek zarar müşterinin sorumluluğundadır.
- Kargo/Nakliye firmasından imza karşılığı teslim alınan ürünlerin eksiksiz ve sağlam olduğundan emin olduktan sonra teslim alınması önemle hatırlatılır.
- Aksi talep edilmedikçe tüm gönderiler anlaşmalı kargo/nakliye firması ile yapılmaktadır.
- Garanti kapsamı dışındaki tüm ürün ve malzeme taleplerinde taşıma bedeli alıcıya aittir.
- Akın Ziraat, küresel ekonomik koşullar ve ham madde fiyatlarındaki değişikliklere dayanarak kampanya satışları yapabilir, fiyatlarda değişikliğe gidebilir. Müşterilerimiz, yapılacak değişikliklerden geçmiş siparişlere yönelik hak talep edemez.
- Bu katalogta belirtilen teknik bilgi, özellik ve resimler, ürün donanımlarına göre değişiklik gösterebilir. Akın Ziraat ve tedarikçileri, bu değişikliklerden dolayı sorumlu tutulamaz.

BANKA	ŞUBE KODU	IBAN
 Ziraat Bankası	DÜZCE / 1676	TR83 0001 0016 7611 9771 4850 16
 HALKBANK	DÜZCE / 327	TR84 0001 2009 3270 0010 0004 73
 YapıKredi	DÜZCE / 147	TR42 0006 7010 0000 0060 7101 87
 TÜRKİYE BANKASI	DÜZCE / 4320	TR37 0006 4000 0014 3201 0458 53
 AKBANK	DÜZCE / 0083	TR60 0004 6000 8388 8000 0302 18
 QNB FINANSBANK	DÜZCE / 867	TR32 0011 1000 0000 0010 1703 82
 DenizBank	DÜZCE / 3350	TR61 0013 4000 0019 3839 4000 01
 Garanti	DÜZCE / 1171	TR98 0006 2001 1710 0006 2948 04
 KUVEYTTÜRK	DÜZCE / 25	TR71 0020 5000 0069 1909 0000 01



YEDEK PARÇA  
0542 266 94 30

SATIŞ SONRASI  
0541 341 40 68



444 52 04



info@akinziraat.com



b4b.akinziraat.com



D-100 Karayolu Üzzeri D.S.İ Yanı No: 432 DÜZCE / TÜRKİYE



# HAKKIMIZDA

1978 yılında Ziraat Teknisyeni Rasim Akın tarafından kurulan firmamız, 45 yılı aşkın deneyimiyle Türkiye'nin tarım sektöründeki öncü kuruluşları arasında yer almaktadır. Küçük bir ilaç bayisi olarak başlayan yolculuğumuz, yenilikçi vizyonumuz ve kaliteden ödün vermeyen yaklaşımımız sayesinde Türkiye geneline yayılan güçlü bir marka haline gelmiştir.

Sürekli büyüyen geniş ürün yelpazemiz, yüksek itibarlı markalarımız, etkin pazarlama ağıımız ve profesyonel satış sonrası desteğimiz ile her geçen gün daha fazla çiftçiye ulaşmaktayız. Türkiye'nin 81 ilinde hizmet veren geniş iş ortağı ağıımızla, müşterilerimizle birlikte büyümeye devam ediyoruz.

Firmamız bünyesinde DAKKIN ve POWER G tescilli markalarımız yer almakta olup, aynı zamanda BAHCO (İsveç), LISAM (İtalya), SEP (İtalya) ve PULMIC (İspanya) markalarının Türkiye distribütörlüğünü yürütmekteyiz. Dünya çapında kendini kanıtlamış bu markaları Akın Ziraat güvencesiyle çiftçilerimizle buluşturuyor, her alanda pratik ve uzun ömürlü çözümler sunuyoruz.

Tarım sektöründeki geniş deneyimimiz ve iddialı vizyonumuz ile çiftçilerimizin tüm ihtiyaçlarını bireye ve çevreye duyarlı bir yaklaşımla karşılıyor, iş ortaklarımızla birlikte tarıma değer katmaya devam ediyoruz.

# İÇİNDEKİLER

5-59



**DAKKIN**

- Motorlu Testereler ve Motorlu Tırpanlar
- Motorlu Yüksek Dal Budama Testereleri
- Üfleme Makineleri ve Toprak Burgu Makineleri
- Çit Biçme ve Çay Toplama Makineleri
- Dal Sarsıcı ve Sarsıcı Aparat
- Akülü Budama Ürünleri
- İlaçlama Makineleri
- Çim Biçme Makineleri
- Jenaratörler
- Motorlar
- Su Motorları
- Basınçlı Yıkama Makineleri
- Sisleme Makinesi ve Basınç Pompaları
- Kar Küreme ve Dal Öğütme Makineleri
- Çapalama Makineleri
- Hayvan Kovucular
- Hamur Karma Makineleri

14-22

**PowerG®**

- Motorlu Tırpanlar
- Toprak Burgu Makineleri ve Burgu Uçları

60-69

**LISAM**

- Zeytin Hasat Makineleri
- Akülü Budama Makasları ve Testereleri



**BAHCO**

70-98

- Zeytin Hasat Makineleri
- Akülü Budama Ürünleri
- Yüksek Dal Budama Testeresi
- Manuel Budama Makasları
- Çift Kollu Budama Makasları
- Budama ve Kolastar Testereler
- Tepe Makası & Uzatma Çubuğu & Setler
- Çit ve Çim Makasları
- Kamp Ürünleri ve Bıçaklar
- Bıçaklar & Baltalar & Balyozlar
- Hobi Bahçe Aletleri
- Eğeler

99-103



PULMIC®

- Pilli İlaçlama Makineleri
- Sırt Tipi İlaçlama Makineleri
- El Tipi İlaçlama Makineleri
- Bitki Bağlama Tabancası ve Bantları
- Tırmıklar ve Saplar

104-110



- Çapa Makineleri
- Çayır Biçme Makineleri
- Çalı ve Ot Parçalama Makineleri

111-115

FLASH®

- Çapa Makineleri ve Aksesuarları

116-124

**AKSESUARLAR**

- Kılavuzlar ve Zincirler
- Yağlar
- Misinalar
- Koruyucu Ekipmanlar  
(Maske, Gözlük, Kulaklık)

125-141

**YEDEKPARÇA**







**DAKKIN**

# **MOTORLU TESTERELELER**





## CS2500S

ÜRÜN KODU: 810719

200 USD

GÜÇ	1,2 hp
SİLİNDİR HACMİ	24,4 cc
KILAVUZ UZUNLUĞU	25 cm
ZİNCİR ÖLÇÜSÜ	91" - 20 diş
YAĞ POMPASI TİPİ	Otomatik
YAĞ/YAKIT KAPASİTESİ	0,14 l - 0,19 l
AĞIRLIK	2,3 kg

Üstten tutmalı kolu ile tek el kullanım. Hafifliği ve 1,2 hp'lik gücü ile kusursuz ve konforlu çalışma sunar.



## CS2500

ÜRÜN KODU: 810722

**143 USD**

GÜÇ	1,2 hp - 0,9 kW
SİLİNDİR HACMİ	25,4 cc
KILAVUZ UZUNLUĞU	25 cm
ZİNCİR ÖLÇÜSÜ	3/8"-91 - 22 diş
YAĞ POMPASI TİPİ	Otomatik
YAĞ/YAKIT KAPASİTESİ	0,18 l - 0,23 l
AĞIRLIK	3,1 kg



## CS2500E

ÜRÜN KODU: 810721

**159 USD**

GÜÇ	1,2 hp - 0,9 kW
SİLİNDİR HACMİ	25,4 cc
KILAVUZ UZUNLUĞU	25 cm
ZİNCİR ÖLÇÜSÜ	1/4" - 30 diş
YAĞ POMPASI TİPİ	Otomatik
YAĞ/YAKIT KAPASİTESİ	0,18 l - 0,23 l
AĞIRLIK	3,1 kg



## CS4000

ÜRÜN KODU: 810723

**173 USD**

GÜÇ	2,0 hp - 1,5 kW
SİLİNDİR HACMİ	39,6 cc
KILAVUZ UZUNLUĞU	41 cm
ZİNCİR ÖLÇÜSÜ	3/8"-91 - 28,5 diş
YAĞ POMPASI TİPİ	Otomatik
YAĞ/YAKIT KAPASİTESİ	0,24 l - 0,41 l
AĞIRLIK	4,3 kg



## CS5060

ÜRÜN KODU: 810724

**187 USD**

GÜÇ	2,7 hp - 2,0 kW
SİLİNDİR HACMİ	49,8 cc
KILAVUZ UZUNLUĞU	46 cm
ZİNCİR ÖLÇÜSÜ	0,325" - 36 diş
YAĞ POMPASI TİPİ	Otomatik
YAĞ/YAKIT KAPASİTESİ	0,26 l - 0,52 l
AĞIRLIK	5 kg



## CS5460

ÜRÜN KODU: 810729

**192 USD**

32 Diş

ÜRÜN KODU: 810727

**202 USD**

34 Diş

GÜÇ	3,0 hp - 2,2 kW
SİLİNDİR HACMİ	54,0 cc
KILAVUZ UZUNLUĞU	46 cm
ZİNCİR ÖLÇÜSÜ	3/8" - 34 diş
YAĞ POMPASI TİPİ	Otomatik
YAĞ/YAKIT KAPASİTESİ	0,19 l - 0,52 l
AĞIRLIK	5,1 kg



## PT140

ÜRÜN KODU: 810730

**179 USD**

GÜÇ	2,0 hp - 1,5 kW
SİLİNDİR HACMİ	39,6 cc
KILAVUZ UZUNLUĞU	41 cm
ZİNCİR ÖLÇÜSÜ	3/8"-91 - 28,5 diş
YAĞ POMPASI TİPİ	Otomatik
YAĞ/YAKIT KAPASİTESİ	0,19 l - 0,40 l
AĞIRLIK	3,9 kg

**YENİ**





# MOTORLU TIRPANLAR

AKÜLÜ TIRPAN

## BK30

ÜRÜN KODU: 810501

973 USD

GÜÇ	2500 W
BOYUT	1800*450*225
AĞIRLIK	5,6 kg
KESME ÇAPI	420 mm
HIZ	2000 - 6000 rpm
BATARYA KAPASİTESİ	500 - 1000 saat

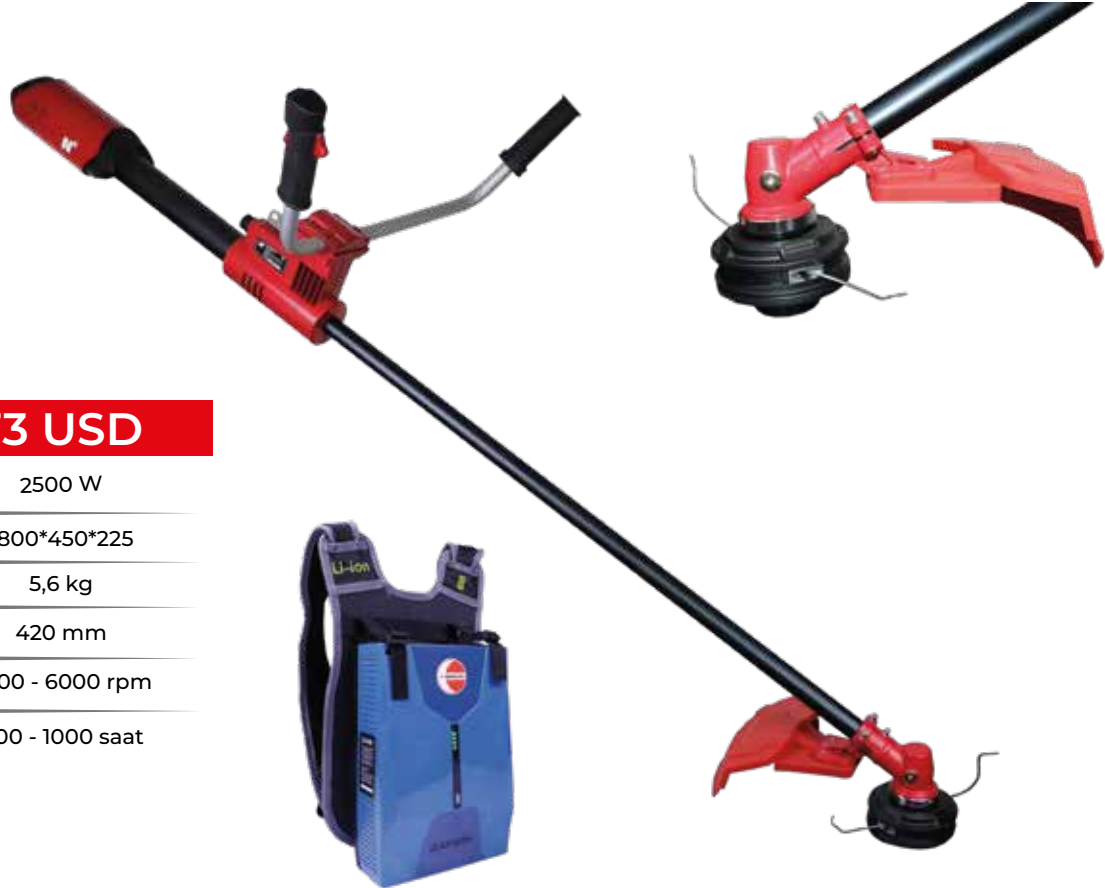

18,2 Ah



## TJ53CG Powered By **Kawasaki**

ÜRÜN KODU: 810311

**607 USD**



### TEKNİK ÖZELLİKLER

ÜRÜN KODU	810311
<b>ÖZELLİKLER</b>	<b>TJ53CG</b>
GÜÇ	3,0 hp - 2,2 kW
SİLİNDİR HACMİ	53,2 cc
TİP	Yan
BORU ÇAPI	28 mm
GİDON	Bisiklet
YAKIT KAPASİTESİ	1,1 l
AĞIRLIK	9,0 kg

## TJ53BG Powered By **Kawasaki**

ÜRÜN KODU: 810412

**622 USD**

Yenilenen ergonomik tasarımıyla Kawasaki gücü en konforlu şekilde sizlerle. Yüksek kalite aksamı ve benzersiz gücüyle tanıdığınız Dakkin şimdi bir adım daha önde.

### TEKNİK ÖZELLİKLER

ÜRÜN KODU	810412
<b>ÖZELLİKLER</b>	<b>TJ53BG</b>
GÜÇ	3,0 hp - 2,2 kW
SİLİNDİR HACMİ	53,2 cc
TİP	Sırt
BORU ÇAPI	28 mm
GİDON	Pilot
YAKIT KAPASİTESİ	1,1 l
AĞIRLIK	11,8 kg



**İLERİ SEVİYE  
BEL DESTEĞİ**



## BG520

ÜRÜN KODU: 810413

224 USD







## CG520

ÜRÜN KODU: 810314

209 USD



## TEKNİK ÖZELLİKLER

ÜRÜN KODU		810413	810314
ÖZELLİKLER		BG520	CG520
GÜÇ		1,9 hp - 1,5 kW	1,9 hp - 1,5 kW
SİLİNDİR HACMİ		52,0 cc	52,0 cc
TİP		Sırt	Yan
BORU ÇAPI		26 mm	26 mm
GİDON		Pilot	Bisiklet
YAKIT KAPASİTESİ		1,1 l	1,1 l
AĞIRLIK		11,0 kg	8,0 kg

## BG630

ÜRÜN KODU: 810414

**286 USD**



## CG630

ÜRÜN KODU: 810316

**281 USD**



## BG63 TEK MOTOR

ÜRÜN KODU: 816261

**173 USD**



## CG63 TEK MOTOR

ÜRÜN KODU: 816262

**130 USD**



## TEKNİK ÖZELLİKLER

ÜRÜN KODU		810414	810316	816261	816262
ÖZELLİKLER		BG630	CG630	BG63	CG63
GÜÇ		2,9 hp - 2,1 kW	2,9 hp - 2,1 kW	2,9 hp - 2,1 kW	2,9 hp - 2,1 kW
SİLİNDİR HACMİ		63,3 cc	63,3 cc	63,3 cc	63,3 cc
TİP		Sırt	Yan	Sırt	Yan
BORU ÇAPI		28 mm	28 mm	-	-
GİDON		Pilot	Bisiklet	-	-
YAKIT KAPASİTESİ		1,3 l	1,3 l	1,3 l	1,3 l
AĞIRLIK		11,3 kg	8,8 kg	6,1 kg	5,0 kg

## BC26E

ÜRÜN KODU: 810320

151 USD

**YENİ**



## CG260E

ÜRÜN KODU: 810319

180 USD



Eğik kafalı motorlu tırpan, çim biçme ve yabancı ot temizleme işleri için kullanılan, motor gücüyle çalışan hafif ve pratik bir bahçe aracıdır. Eğik kafa tasarımı, dar ve zor erişilen alanlarda kolay kullanım sağlar.

## TEKNİK ÖZELLİKLER

ÜRÜN KODU		810320	810319
ÖZELLİKLER		BC26E	CG260E
GÜÇ		1,0 hp - 0,8 kW	1,0 hp - 0,8 kW
SİLİNDİR HACMİ		25,4 cc	25,4 cc
TİP		Eğik	Eğik
BORU ÇAPI		26 mm	26 mm
GİDON		Pilot	Pilot
YAKIT KAPASİTESİ		0,75 l	0,75 l
AĞIRLIK		5,0 kg	5,0 kg



## BC52B-C

ÜRÜN KODU: 790401

195 USD



## FİYAT PERFORMANS ÜRÜNÜ

Fiyat performans alanında bir numara: POWERG BC52 serisi hesaplı fiyatıyla beraber uzun süreli bir kullanım sunar. 52cc motoru ile zorlu şartlarda bile yüksek performans gösterir, kullanıcıyı yarı yolda bırakmaz.

## BC52C

ÜRÜN KODU: 790301

173 USD

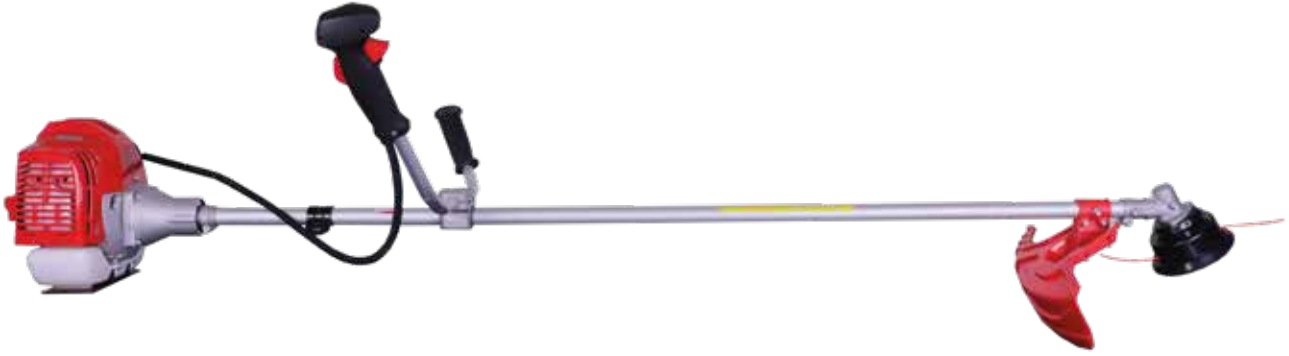

## TEKNİK ÖZELLİKLER

ÜRÜN KODU		790401	790301
ÖZELLİKLER		BC52B-C	BC52C
GÜÇ		1,9 hp - 1,5 kW	1,9 hp - 1,5 kW
SİLİNDİR HACMİ		52 cc	52 cc
TİP		Sırt	Yan
BORU ÇAPI		26 mm	26 mm
GİDON		Pilot	Bisiklet
YAKIT KAPASİTESİ		0,9 l	0,9 l
AĞIRLIK		10,0 kg	8,0 kg





**DAKKIN**

# **YÜKSEK DAL BUDAMA & MULTİ TIRPAN**







## DGJ330

ÜRÜN KODU: 810315

**360 USD**

GÜÇ	1,2 hp - 0,9 kW
SİLİNDİR HACMİ	33 cc
DEVİR/DK	6500 rpm
TİP	Yan
GİDON	Pilot
YAKIT KAPASİTESİ	0,85 l
AĞIRLIK	3,6 kg

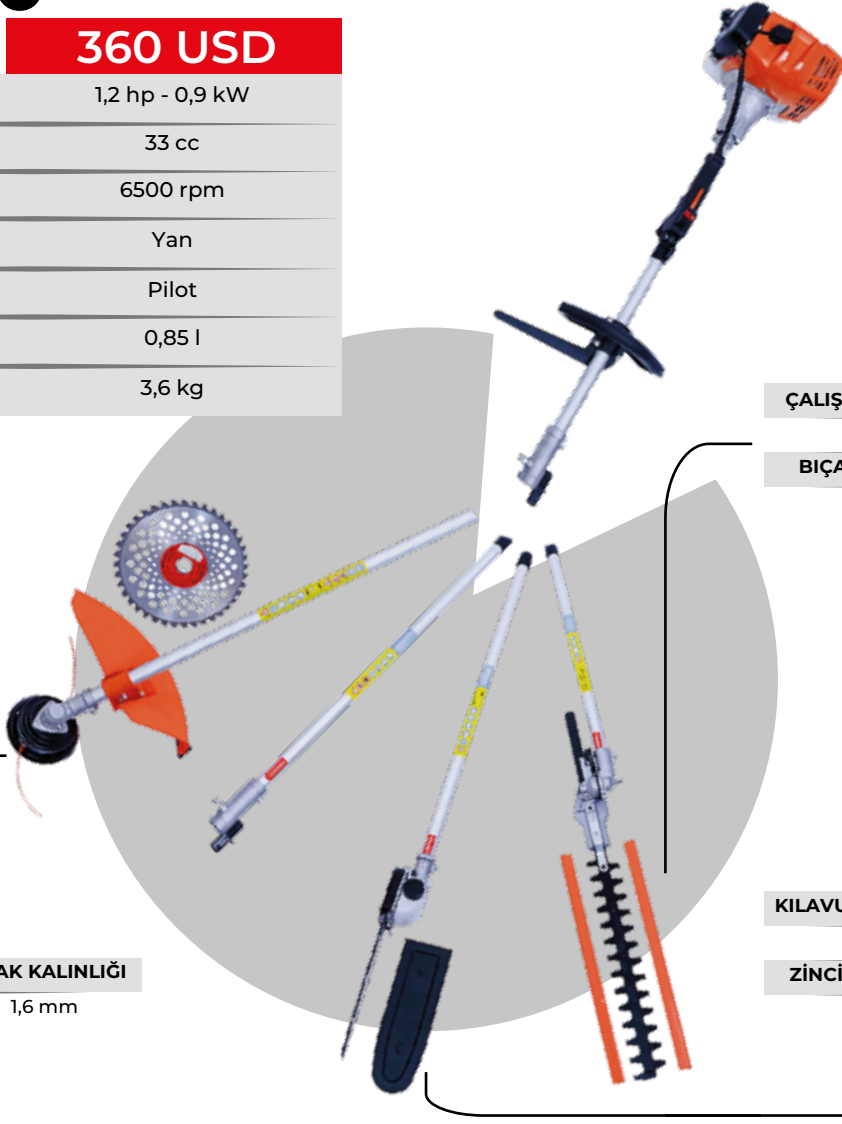

ÇALIŞMA UZUNLUĞU	410 mm	BIÇAK ARALIĞI	23 mm
BIÇAK UZUNLUĞU	59 mm	DÖNME AÇISI	260 °

KESME GENİŞLİĞİ	255 mm / 2	BIÇAK KALINLIĞI	1,6 mm
-----------------	------------	-----------------	--------

KILAVUZ UZUNLUĞU	10"	ZİNCİR ÖLÇÜSÜ	91
ZİNCİR DİŞ SAYISI	19,5 diş	YAĞ KAPASİTESİ	0,15 l

## GZJ260AE

ÜRÜN KODU: 810759

**411 USD**

GÜÇ	1,0 hp - 0,7 kW
SİLİNDİR HACMİ	26 cc
KILAVUZ UZUNLUĞU	30 cm
ZİNCİR ÖLÇÜSÜ	3/8" - 91/22 diş
YAĞ POMPASI TİPİ	Otomatik
UZUNLUK	4,1 M - 2,3 m
AĞIRLIK	9,5 kg



4 Metreye kadar uzanan boyutu ile yüksek dallara ulaşın.







**DAKKIN**

# ÜFLEME MAKİNELERİ





## EB985

ÜRÜN KODU: 811164

**324 USD**

GÜÇ	5,0 hp - 3,7 kW
SİLİNDİR HACMI	75,6 cc
HAVA DEBİSİ	1620 M <sup>3</sup> / saat
YAKIT KAPASİTESİ	2,2 l
AĞIRLIK	13,3 kg

Yenilenen EB985 sizlerle. Gücünden ve dayanıklılığından hiçbir şey kaybetmeyen efsane artık yenilendi.

YÜKSEK HAVA DEBİSİ

GÜÇLÜ MOTOR

## EB280

ÜRÜN KODU: 811161

195 USD

Güçlü üfleme ile kolay ve zahmetsiz bahçe temizliğine hazır olun.



1,0 hp - 0,8 kW



540 m<sup>3</sup> / saat



4,0 kg

## EBV280

ÜRÜN KODU: 811165

209 USD

Güçlü vakum etkisi ve sepeti ile bahçe temizliğinizde büyük değişimler yaratın.



1,0 hp - 0,8 kW



540 m<sup>3</sup> / saat



5,8 kg



## TEKNİK ÖZELLİKLER

ÜRÜN KODU	811161	811165
ÖZELLİKLER	EB280	EBV280
GÜÇ	1,0 hp - 0,8 kW	1,0 hp - 0,8 kW
SİLİNDİR HACMİ	26 cc	26 cc
YAKIT KAPASİTESİ	0,5 l	1,5 l
HAVA DEBİSİ	540 m <sup>3</sup> / saat	540 m <sup>3</sup> / saat
AĞIRLIK	4 kg	5,8 kg
SEPET KAPASİTESİ	-	50 l





**DAKKIN**

# **TOPRAK BURGU MAKİNELERİ**







ERGONOMİK  
TUTMA KOLU



30 CM UÇ  
SEÇENEĞİ

## AG65

ÜRÜN KODU: 811301

**303 USD**

ÜRÜN KODU: 811302

**250 USD**

(Boş makine)

GÜÇ	2,9 hp - 2,1 kW
SİLİNDİR HACMİ	63 cc
YAKIT KAPASİTESİ	1,3 l
BURGU BOYUTU	30 cm
AĞIRLIK	14,4 kg





## GD590

ÜRÜN KODU: 811365

**216 USD**

(Boş makine)



ÜRÜN KODU	811366	811367	811368
ÖZELLİKLER	GD590-10CM	GD590-15CM	GD590-20CM
GÜÇ	2,1 hp - 1,6 kW	2,1 hp - 1,6 kW	2,1 hp - 1,6 kW
SİLİNDİR HACMİ	52 cc	52 cc	52 cc
YAKIT KAPASİTESİ	1,2 L	1,2 L	1,2 L
BURGU BOYUTU	10 cm	15 cm	20 cm
AĞIRLIK	9,5 kg	9,5 kg	9,5 kg
<b>FİYAT</b>	<b>268 USD</b>	<b>273 USD</b>	<b>284 USD</b>

## AG52

ÜRÜN KODU: 791301

**195 USD**

(Boş makine)



ÜRÜN KODU	791302	791303	791304
ÖZELLİKLER	AG52-10	AG52-15	AG52-20
GÜÇ	2,1 hp - 1,6 kW	2,1 hp - 1,6 kW	2,1 hp - 1,6 kW
SİLİNDİR HACMİ	52 cc	52 cc	52 cc
YAKIT KAPASİTESİ	1,2 L	1,2 L	1,2 L
BURGU BOYUTU	10 cm	15 cm	20 cm
AĞIRLIK	9,2 kg	9,2 kg	9,2 kg
<b>FİYAT</b>	<b>218 USD</b>	<b>241 USD</b>	<b>265 USD</b>

## BURGU UÇLARI

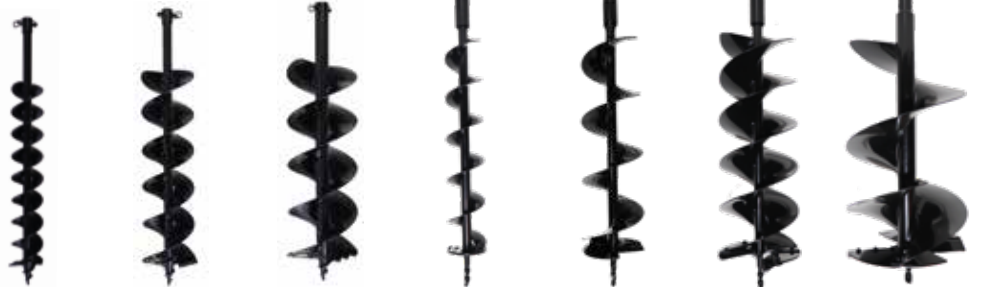

ÜRÜN KODU	DAKKIN			PowerG®			
	811768	811766	811767	791701	791702	791703	791704
ÖZELLİKLER	BURGU UCU	BURGU UCU	BURGU UCU	BURGU UCU	BURGU UCU	BURGU UCU	BURGU UCU
ÇAP	10 cm	15 cm	20 cm	10 cm	15 cm	20 cm	30 cm
HELEZON	Çift	Çift	Çift	-	-	-	-
<b>FİYAT</b>	<b>62 USD</b>	<b>67 USD</b>	<b>78 USD</b>	<b>33 USD</b>	<b>56 USD</b>	<b>80 USD</b>	<b>103 USD</b>





**DAKKIN**

# **AKÜLÜ BUDAMA ÜRÜNLERİ**





## DLJ-6

ÜRÜN KODU: 813706

130 USD

BATARYA VOLTAJI	21,0 V
BATARYA KAPASİTESİ	3,0 Ah
KILAVUZ UZUNLUĞU	20 cm
ZİNCİR ÖLÇÜSÜ	3/8"
ZİNCİR HIZI	10 m / sn
UZUNLUK(Uzatma dahil)	2,8 m
KESME ÇAPI	150 mm
AĞIRLIK	1,4 kg

Avrupa ülkelerini kasıp kavuran IMOUM ürünleri artık DAKKIN ortaklığıyla sizlerle. Rakiplerine göre benzersiz performans, kritik aksamda 2 yıl koşulsuz garanti, dolu dolu hediyeleri ve döner başlıklı uzatma çubuğu uyumuyla DLJ-6 modeli en zorlu koşullarda bile hep yanınızda.



## DLJ BUDAMA SETİ

ÜRÜN KODU: 813710

332 USD

## SET İÇERİĞİ

- DLJ-6 Akülü Budama Testeresi
- Uzatma Çubuğu
- DLJ-32 Akülü Budama Makası
- 3,0 Ah Batarya 2 Adet

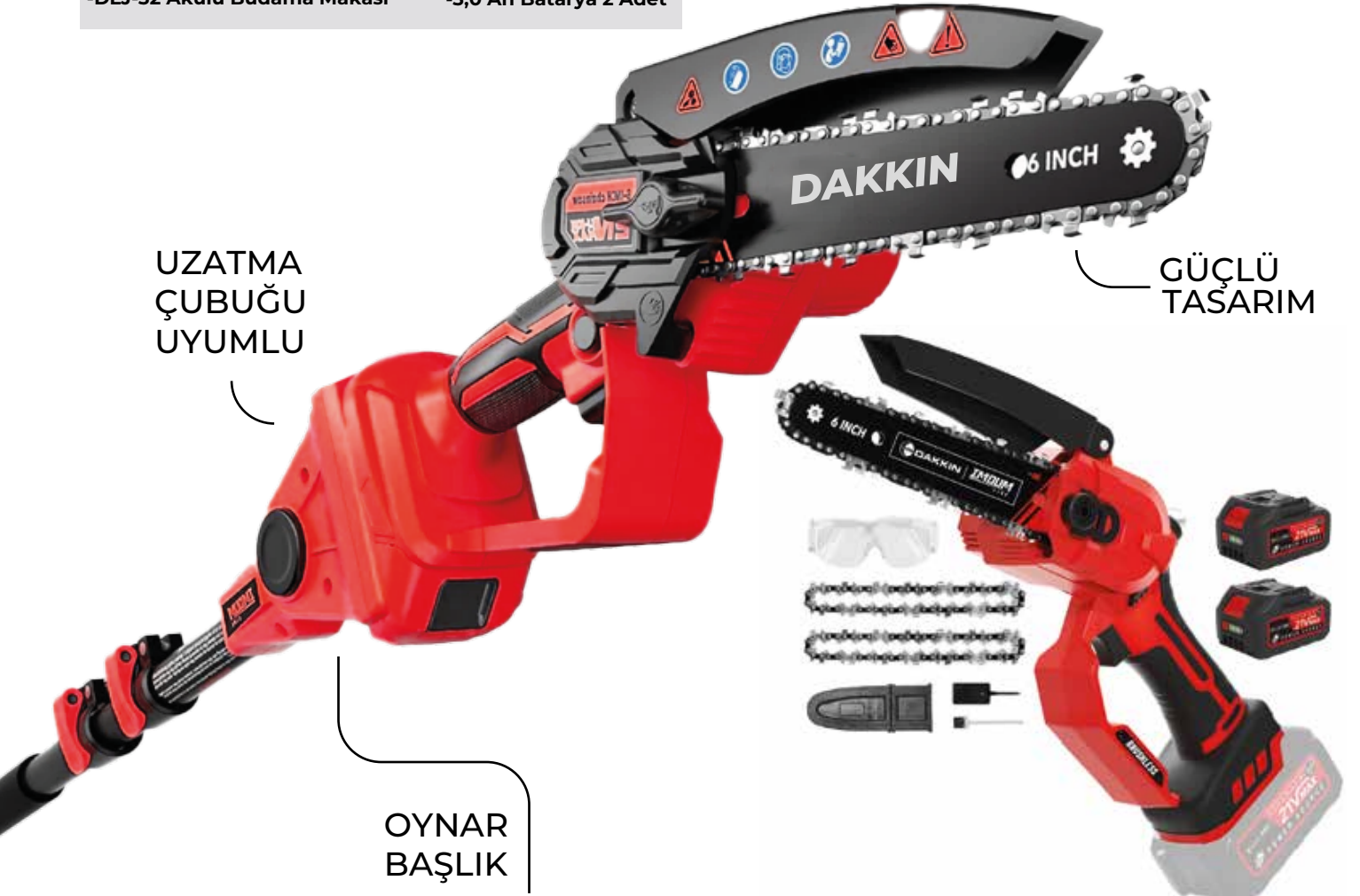



## DLJ-32

ÜRÜN KODU: 813705

**144 USD**

BATARYA VOLTAJİ	21,0 V Li-ion - 2,0 Ah
KESME ÇAPI	32 mm
ÇALIŞMA SÜRESİ	6 saat
ŞARJ SÜRESİ	2 saat
BATARYA ADEDİ	2 adet
BATARYA AĞIRLIĞI	120 gr
AĞIRLIK	1,25 kg



## DLJ-01

ÜRÜN KODU: 811601

**72 USD**

### UYUMLU MODELLER

- DLJ-6 Akülü Budama Testeresi
- DLJ-32 Akülü Budama Makası

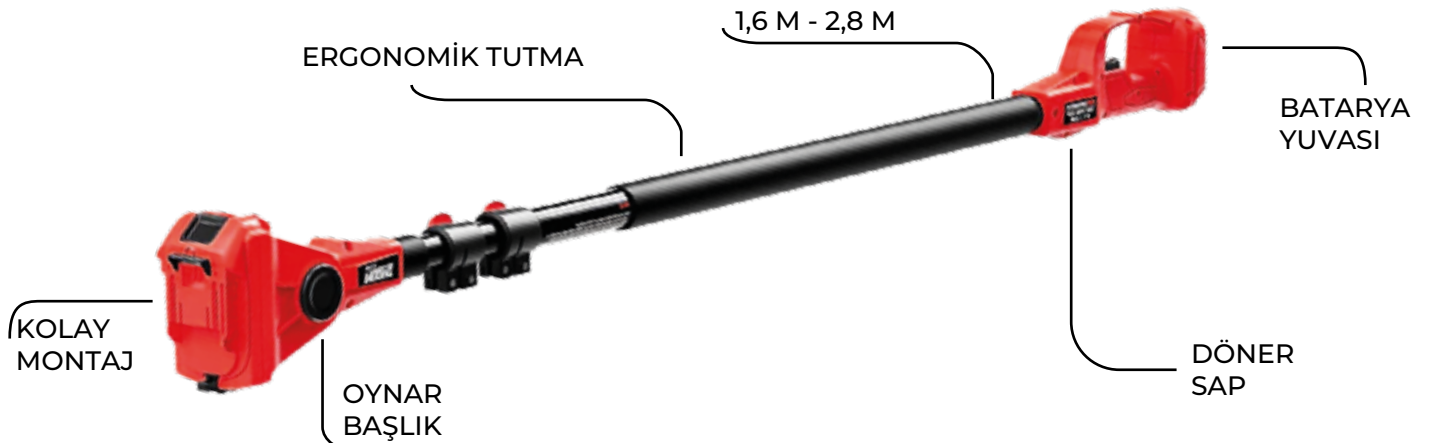



## CSB023

ÜRÜN KODU: 813708

**252 USD**

AKÜ GÜÇ	21V, 4Ah Li-ion
ZİNCİR/KILAVUZ ÖLÇÜSÜ	1/4" - 23,5 diş / 8"
BATARYA ADEDİ	2 adet
ŞARJ SÜRESİ	2-2,5 saat
ÇALIŞMA SÜRESİ	3-5 saat
BATARYA AĞIRLIĞI	500 gr
AĞIRLIK	2 kg

Daha büyük zincir ve kılavuz ile, profesyonellere hitap eden güçlü tasarım.



## CSB09

ÜRÜN KODU: 811603

**115 USD**

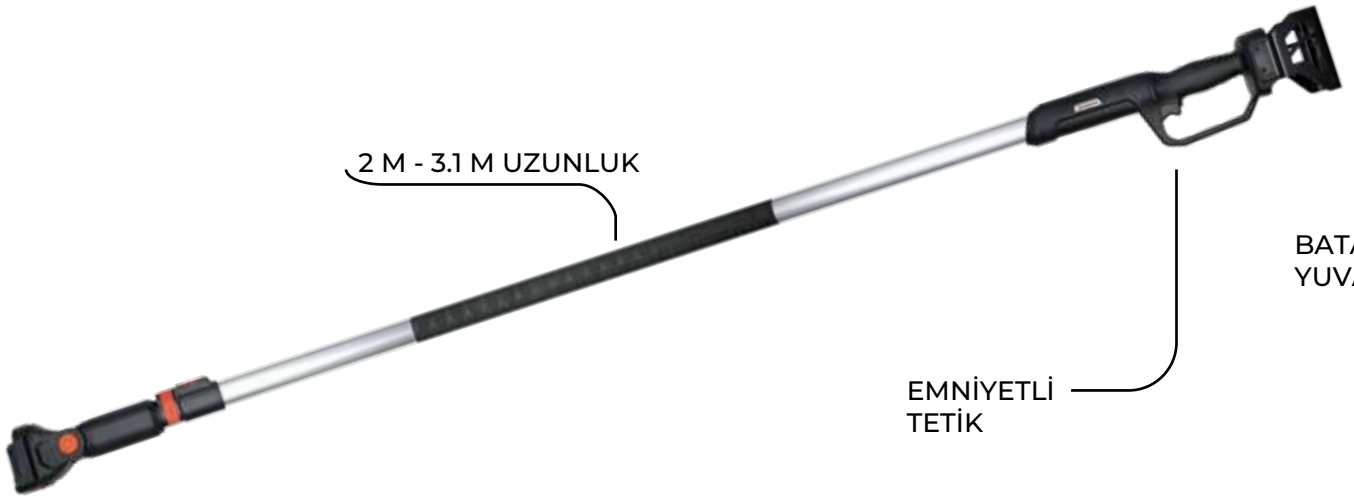

2 M - 3.1 M UZUNLUK

BATARYA YUVASI

EMNİYETLİ TETİK

# SC8611

ÜRÜN KODU: 813707

**267 USD**

AKÜ GÜÇ	21V, 4Ah Li-ion
KESME ÇAPI	40 mm
BATARYA ADEDİ	2 adet
BATARYA AĞIRLIĞI	330 gr
ŞARJ SÜRESİ	3-4 saat
ÇALIŞMA SÜRESİ	4-6 saat
AĞIRLIK	970 gr

40 mm kesim genişliği ile kalın dalları rahatlıkla budayın. Teleskopik sap ile yüksek dalların budaması çok kolay.



# SC7612

ÜRÜN KODU: 811602

**94 USD**

1,5 - 2,1 M UZUNLUK

BATARYA YUVASI

TETİK







## 32 PRO

ÜRÜN KODU: 813703

**252 USD**

AKÜ GÜÇ	14,4V, 2,5Ah Li-ion
KESME ÇAPI	32 mm
BATARYA ADEDİ	3 adet
BATARYA AĞIRLIĞI	322 gr
ŞARJ SÜRESİ	2-3,5 saat
ÇALIŞMA SÜRESİ	2-3,5 saat
AĞIRLIK	725 gr



## WS32Y

ÜRÜN KODU: 813702

**202 USD**

AKÜ GÜÇ	16,8V, 2,6Ah li-ion
KESME ÇAPI	32 mm
BATARYA ADEDİ	2 adet
BATARYA AĞIRLIĞI	220 gr
ŞARJ SÜRESİ	2 saat
ÇALIŞMA SÜRESİ	2,5-3,5 saat
AĞIRLIK	725 gr



## WS35Y

ÜRÜN KODU: 813701

**281 USD**

AKÜ GÜÇ	16,8V, 4,5Ah li-ion
KESME ÇAPI	35 mm
BATARYA ADEDİ	2 adet
BATARYA AĞIRLIĞI	320 gr
ŞARJ SÜRESİ	2 saat
ÇALIŞMA SÜRESİ	3-4 saat
AĞIRLIK	825 gr





# DAKKIN

# ÇİT BIÇME MAKİNELERİ



GÜÇLÜ  
MOTOR



ERGONOMİK  
TUTMA KOLU



EKSTRA KESKİN  
EKSTRA DAYANIKLI  
BIÇAKLAR



## H65D

GÜÇ	1,0 hp - 0,75 kW
DEVİR	6000-7300 rpm
BIÇAK TİPİ	Çift bıçak
BIÇAK UZUNLUĞU	65 cm
KESİCİ DIŞ ARALIĞI	35 mm
AĞIRLIK	3,5 kg

	AP-05	AP-02
ÜRÜN KODU	813502	813503
BATARYA KAPASİTESİ	36 V - 13,0 Ah	36 V - 18,2 Ah
ÇALIŞMA SÜRESİ	6 - 8 saat	8 - 10 saat
ŞARJ SÜRESİ	4 - 5 saat	6 - 7 saat
AĞIRLIK	3,4 kg	5,25 kg
FİYAT	<b>750 USD</b>	<b>876 USD</b>

## SLP500

ÜRÜN KODU: 813361

**187 USD**



1,0 HP - 0,8 kW



50 cm



4,7 kg

## SLP600

ÜRÜN KODU: 813360

**209 USD**



1,0 HP - 0,8 kW



60 cm



5,5 kg



DAKKIN benzinli çit budama makineleri, keskin bıçakları ile hassas, istenen uzunlukta ve kolay bitki budama imkanı sunar. Hafiflik amaçlandığında SLP500 modeli, daha uzun bıçak istendiğinde ise SLP600 modeli tercih edilebilir.

## TEKNİK ÖZELLİKLER

ÜRÜN KODU	813361	813360
ÖZELLİKLER	SLP500	SLP600
GÜÇ	1,0 hp - 0,8 kW	1 HP - 0,8 kW
SİLİNDİR HACMİ	22,5 cc	22,5 cc
BIÇAK TİPİ	Çift bıçak	Çift bıçak
BIÇAK UZUNLUĞU	50 cm	60 cm
KESİCİ DİŞ ARALIĞI	35 mm	35 mm
YAKIT KAPASİTESİ	0,3 l	0,5 l
AĞIRLIK	4,7 kg	5,5 kg





# DAKKIN

# ÇAY TOPLAMA MAKİNELERİ

## K30

ÜRÜN KODU: 813367

**500 USD**

TİP	Sensörlü
DEVİR AYARI	İki kademeli
BIÇAK UZUNLUĞU	30 cm
BATARYA ADEDİ	3 adet
AĞIRLIK(Batarya Dahil)	1,3 kg
BATARYA KAPASİTESİ	16,8V - 3,5 Ah
ÇALIŞMA SÜRESİ(Tek Batarya)	1 - 1,5 saat

Fındık filizlerini almak için veya üzüm bağlarının budanması için kullanılabilir.



## BATARYA SETİ

ÜRÜN KODU: 816526

**140 USD**

Set içerisinde 3 adet batarya ve şarj aleti mevcuttur.



## TEK BATARYA

ÜRÜN KODU: 816525

**45 USD**

## KABLOSUZ AKÜ İLE GÜÇ ELİNİZDE!





## D30

CÜÇ	750 W
DEVİR AYARI	İki kademeli
BIÇAK UZUNLUĞU	30 cm
DEVİR	5200 rpm/dak
AĞIRLIK	1,3 kg

Hem en iyi, hem en güvenli DAKKIN çay toplama makinesi 2025 modelinde güvenlik sensörü içermektedir. Bu sensör sayesinde ürünü elinizden düşürmeniz durumunda saniyenin onda birinden kısa bir sürede bıçaklar durur, kullanıcıya zarar önlenmiş olur.

Fındık filizlerini almak için veya üzüm bağlarının budanması için kullanılabilir.

# SENSÖRLÜ



	AP-01	AP-03	AP-05	AP-02
ÜRÜN KODU	813362	813365	813366	813364
BATARYA KAPASİTESİ	36 V - 7,8 Ah	36 V - 10,4 Ah	36 V - 13,0 Ah	36 V - 18,2 Ah
ÇALIŞMA SÜRESİ	8 - 10 saat	8 - 10 saat	8 - 10 saat	8 - 10 saat
ŞARJ SÜRESİ	2-3 saat	3-4 saat	4-5 saat	6-7 saat
AĞIRLIK	1,9 kg	3,0 kg	3,4 kg	5,25 kg
FİYAT	570 USD	627 USD	684 USD	810 USD



# DAKKIN

# ZEYTİN HASAT MAKİNELERİ

## DAKKIN N<sup>+</sup> ZEYTİN HASAT MAKİNESİ

36 V

1440 W

FIRÇASIZ MOTOR

2,2 - 3,3 METRE UZUNLUK

İKİ KADEMELİ DEVİR AYARI

2,8 KG

## YENİ



## YER AKÜLÜ

ÜRÜN KODU: 815730

560 USD

ÜRÜN KODU		815735	815734	815732
BATARYA KAPASİTESİ		36 V - 7,8 Ah	36 V - 13,0 Ah	36 V - 18,2 Ah
ÇALIŞMA SÜRESİ		5 - 6 saat	8 - 10 saat	14 - 16 saat
ŞARJ SÜRESİ		2-3 saat	4-5 saat	6-7 saat
BATARYA AĞIRLIĞI		1,9 kg	3,4 kg	5,25 kg
FİYAT		776 USD	890 USD	950 USD



## EFE SARSICI 1000S

ÜRÜN KODU: 815801



### ÇENE LASTİĞİ

ÜRÜN KODU: 811770

MOTOR	SİLİNDİR HACMİ	YAKIT	YAKIT KAPASİTESİ	KANCA
3,1 hp	64 cc	Benzin	1,3 l	42 mm sert alaşım
BORU	VURUŞ	HASAT KAPASİTESİ	GÖVDE	AĞIRLIK
2-3,5 m / teleskoik	2350 / dk	2500 kg / gün	Anti vibrasyon	12 kg

## SP900 SARSICI APARAT

ÜRÜN KODU: 991686



### ÇENE LASTİĞİ

ÜRÜN KODU: 811769

MOTOR	ŞANZİMAN	KANCA	VURUŞ	HASAT KAPASİTESİ
Sırt tipi tirpan uyumlu	Yağlamasız, kapalı	32 mm sert alaşım	4300 / dk	2000 kg / gün
UZUNLUK	KULLANIM	GÖVDE	TETİK	AĞIRLIK
247 cm	4-4,5 m	Anti vibrasyon tutamaç	Gövdeye sabit	5,1 kg



**DAKKIN**

# BATARYALAR



## AP-01

ÜRÜN KODU: 816520

**420 USD**

### UYUMLU MODELLER

- BK-30 Akülü Tırpan Makinesi
- D30 Akülü Çay Toplama Makinesi
- HD65 Akülü Çit Budama Makinesi
- Zeytin Hasat Makineleri



36 V



7,8 Ah



2-3 saat



1,99 kg



## AP-03

ÜRÜN KODU: 816523

**470 USD**

### UYUMLU MODELLER

- BK-30 Akülü Tırpan Makinesi
- D30 Akülü Çay Toplama Makinesi
- HD65 Akülü Çit Budama Makinesi
- Zeytin Hasat Makineleri



36 V



10,4 Ah



3-4 saat



3,0 kg



## AP-05

ÜRÜN KODU: 816524

**540 USD**

### UYUMLU MODELLER

- BK-30 Akülü Tırpan Makinesi
- D30 Akülü Çay Toplama Makinesi
- HD65 Akülü Çit Budama Makinesi
- Zeytin Hasat Makineleri



36 V



13,0 Ah



4-5 saat



3,4 kg



## AP-02

ÜRÜN KODU: 816521

**725 USD**

### UYUMLU MODELLER

- BK-30 Akülü Tırpan Makinesi
- D30 Akülü Çay Toplama Makinesi
- HD65 Akülü Çit Budama Makinesi



36 V



18,2 Ah



6-7 saat



5,25 kg



## AP003718

ÜRÜN KODU: 816511

**637 USD**

### UYUMLU MODELLER

- Tüm 30 - 36 V Makinelere Uyumludur



33 V



18,2 Ah



6-7 saat



4,4 kg



## AP005018

ÜRÜN KODU: 816510

**714 USD**

### UYUMLU MODELLER

- Tüm 44 - 48 V Makinelere Uyumludur



44 V



18,0 Ah



6-7 saat



4,7 kg







# DAKKIN

# BATARYA DÖNÜŞÜM KİTİ

## BK001 BATARYA DÖNÜŞÜM KİTİ

ÜRÜN KODU: 815707

**637 USD**

\*\*ZEYBEK ZEYTİN HASAT MAKİNESİ UYUMLUDUR.

**3 ADET  
BATARYA**



**TAM GÜN  
ÇALIŞMA**



BATARYA VOLTAJİ	37,4 V - 4,0 Ah
ÇALIŞMA SÜRESİ (Tek Batarya)	2,5 - 3 saat
ŞARJ SÜRESİ (Tek Batarya)	2 - 3 saat
BATARYA AĞIRLIĞI	900 gr
SAP AĞIRLIĞI	440 gr

### BATARYA

ÜRÜN KODU: 815708

**159 USD**

### BEL BATARYA ADAPTÖRÜ

ÜRÜN KODU: 815709

**37 USD**

### SIRT BATARYA ADAPTÖRÜ

ÜRÜN KODU: 815710

**30 USD**

### 8 METRE KABLO

ÜRÜN KODU: 815711

**91 USD**





**DAKKIN**

# **İLAÇLAMA POMPALARI**



## HY16L AKÜLÜ POMPA

ÜRÜN KODU: 811972

**50 USD**

HACİM	16 L
ÇALIŞMA BASINCI	4 Bar
POMPA TİPİ	Diyafram
HORTUM UZUNLUĞU	1,3 M
PÜSKÜRTME MESAFESİ	2 - 7 M
AĞIRLIK	5,5 kg

 Tek çıkışlı nozul



 Çift çıkışlı nozul



 Dört çıkışlı nozul





## NS16 KOLLU POMPA

ÜRÜN KODU: 811868

**40 USD**

HACİM	16 l
ÇALIŞMA BASINCI	2-3 bar
İŞ KAPASİTESİ	1 Depo - 1500 m <sup>2</sup>
SIVI ATIŞ MİN.	Maks. 2 m / 7 m
AĞIRLIK	3,1 kg

## OS768 PULVERİZATÖR

ÜRÜN KODU: 812181

**177 USD**

GÜÇ	1,0 hp - 0,8 kW
SİLİNDİR HACMİ	25,6 cc
HACİM	25 l
SIVI ATIŞ MİN.	Maks. 1 m - 12 m
SIVI ATIŞ DEBİSİ	8 - 10 Lt / dk
MAKSİMUM BASINÇ	25 bar
YAKIT DEPO KAPASİTESİ	0,6 l
AĞIRLIK	11 kg



## S9900

ÜRÜN KODU: 812071

**166 USD**

MOTOR HIZI	20,000 rpm
DAMLACIK BOYUTLARI	5 - 50 µl
DEPO KAPASİTESİ	6 l
SPREY MESAFESİ	6 - 8 m
GÜÇ	110 - 220 V / 50 hz
AĞIRLIK	2,7 kg



## OS22

ÜRÜN KODU: 812174

**105 USD**

MAKSİMUM DEVİR	1200 rpm/dk
DEBİ	780 - 1320 l/s
ÇALIŞMA BASINCI	45 bar
PİSTON SAYISI	3
AĞIRLIK	7,5 kg



## OS30

ÜRÜN KODU: 812175

**136 USD**

MAKSİMUM DEVİR	1200 rpm/dk
DEBİ	1800 - 2400 l/s
ÇALIŞMA BASINCI	45 bar
PİSTON SAYISI	3
AĞIRLIK	12 kg



# BASINÇLI YIKAMA MAKİNELERİ



## LT707G25

ÜRÜN KODU: 819931

281 USD

MOTOR TİPİ/GÜCÜ	AĞIRLIK
İNDÜKSİYON / 2500 W	22 KG
MAKSİMUM BASINÇ	ÜRÜN BOYUTU
195 BAR	415 x 338 x 910

**YENİ**



## LT40718

ÜRÜN KODU: 819932

130 USD

MOTOR TİPİ/GÜCÜ	AĞIRLIK
KARBON / 1800 W	8 KG
MAKSİMUM BASINÇ	ÜRÜN BOYUTU
140 BAR	293 x 286 x 767

**YENİ**





**DAKKIN**

# ÇİM BİÇME MAKİNELERİ



## D46

ÜRÜN KODU: 813082

**389 USD**

MOTOR	LONCIN
SİLİNDİR HACMİ	139 cc
ŞASI	Çelik
İLERLEME	İtmeli
KESME YÜKSEKLİĞİ	20 - 80 Mm
KESME GENİŞLİĞİ	46 cm
SEPET KAPASİTESİ	60 L
TEKERLEKLER	Ön 7" / Arka 8"



## D51

ÜRÜN KODU: 813083

**483 USD**

MOTOR	LONCIN
SİLİNDİR HACMİ	166 cc
ŞASI	Çelik
İLERLEME	İtmeli
KESME YÜKSEKLİĞİ	20 - 80 Mm
KESME GENİŞLİĞİ	51 cm
SEPET KAPASİTESİ	60 L
TEKERLEKLER	Ön 8" / Arka 9,5"



## D51T

ÜRÜN KODU: 813084

**570 USD**

MOTOR	LONCIN
SİLİNDİR HACMİ	166 cc
ŞASI	Çelik
İLERLEME	Şanzımanlı
KESME YÜKSEKLİĞİ	20 - 80 Mm
KESME GENİŞLİĞİ	51 cm
SEPET KAPASİTESİ	60 L
TEKERLEKLER	Ön 8" / Arka 9,5"





# LM1200

ÜRÜN KODU: 813101

151 USD

# LM1800

ÜRÜN KODU: 813102

238 USD



## TEKNİK ÖZELLİKLER

ÜRÜN KODU	813101	813102
ÖZELLİKLER	LM1200	LM1800
GÜÇ	1200 W	1800 W
YÜKSEKLİK AYARI	3 Kademeli 20 - 60 Mm	3 Kademeli 20 - 60 Mm
KESME GENİŞLİĞİ	33 cm	40 cm
SEPET KAPASİTESİ	30 L	45 L
TEKERLEKLER	140 / 160 Mm	160 / 200 Mm



# D76 ÇİM BİÇME TRAKTÖRÜ

ÜRÜN KODU: 813081

**2812 USD**

GÜÇ	11,18 kW - 15 hp
SİLİNDİR HACMİ	432 cc
MOTOR	LONCIN
ŞASI	Çelik
VİTES	5 İleri 1 Geri
KESME YÜKSEKLİĞİ	20 - 90 mm
KESME GENİŞLİĞİ	30" - 76 cm
SEPET KAPASİTESİ	170 L
TEKERLEKLER	Ön 10" / Arka 15"

• 15 HP MOTOR GÜCÜ

• KENDİ SEGMENTİNDEKİ  
**TEK MAKİNE**

• ÜSTÜN MANEVRA İMKANI  
**İLE KOLAY KULLANIM**





# DAKKIN

# BENZİNLİ MOTORLAR



## DH212

ÜRÜN KODU: 816218

**204 USD**

GÜÇ	7,0 hp
SİLİNDİR HACMİ	212 cc
KRANK TİPİ	Kamalı
KRANK ÇAPI / BOYU	19 mm / 58 mm
ÇALIŞTIRMA	İpli
YAĞ/YAKIT KAPASİTESİ	0,6 l / 3,1 l
AĞIRLIK	15 kg



## DK170

ÜRÜN KODU: 816219

**209 USD**

GÜÇ	7,0 hp
SİLİNDİR HACMİ	212 cc
KRANK TİPİ	Frezeli
KRANK ÇAPI / BOYU	19 mm / 35 mm
ÇALIŞTIRMA	İpli
YAĞ/YAKIT KAPASİTESİ	0,6 l / 3,6 l
AĞIRLIK	18 kg



## DKC170

ÜRÜN KODU: 816215

**173 USD**

DEVİR	3600 rpm
SİLİNDİR HACMİ	173 cc
YAKIT KAPASİTESİ	1 l
YAĞ KAPASİTESİ	0,4 l
HIZ AYARI	Sabit
AĞIRLIK	7,9 kg
KRANK ÖLÇÜLERİ	22 mm - 60 mm



## DKC200-60

ÜRÜN KODU: 816216

**202 USD**

DEVİR	3600 rpm
SİLİNDİR HACMİ	200 cc
YAKIT KAPASİTESİ	1,2 l
YAĞ KAPASİTESİ	0,5 l
HIZ AYARI	Sabit
AĞIRLIK	10,5 kg
KRANK ÖLÇÜLERİ	22 mm - 60 mm



## DKC200-80

ÜRÜN KODU: 816217

**202 USD**

DEVİR	3600 rpm
SİLİNDİR HACMİ	200 cc
YAKIT KAPASİTESİ	1,2 l
YAĞ KAPASİTESİ	0,5 l
HIZ AYARI	Sabit
AĞIRLIK	10,5 kg
KRANK ÖLÇÜLERİ	22 mm - 80 mm





# SU MOTORLARI

## FP15

ÜRÜN KODU: 812410

### YENİ

224 USD



## DK15

ÜRÜN KODU: 812451

227 USD



## DK20

ÜRÜN KODU: 812452

245 USD



## DK30

ÜRÜN KODU: 812453

267 USD



**FP20**

ÜRÜN KODU: 812411

**YENİ**

**267 USD**



**2"**



**FP30**

ÜRÜN KODU: 812412

**YENİ**

**296 USD**



**3"**



**FP20H2**

ÜRÜN KODU: 812413

**YENİ**

**375 USD**

**YÜKSEK BASINÇLI**



**2"**

Yüksek Basıncı



**TEKNİK ÖZELLİKLER**

ÜRÜN KODU	812410	812451	812452	812453	812411	812412	812413
ÖZELLİKLER	FP15	DK15	DK20	DK30	FP20	FP30	FP20H2
GÜÇ	3,0 hp	1,3 hp	5,5 hp	6,5 hp	6,5 hp	6,5 hp	7,0 hp
SİLİNDİR HACMİ	57,2 cc	35,8 cc	163 cc	196 cc	196 cc	196 cc	208 cc
ÇALIŞTIRMA	İpli	İpli	İpli	İpli	İpli	İpli	İpli
YAĞ/YAKIT KAPASİTESİ	0,35 L / 1,4 L	0,35 L / 1,4 L	0,6 L / 3,6 L	0,6 L / 3,6 L	0,6 L / 3,6 L	0,6 L / 3,6 L	0,6 L / 3,6 L
GİRİŞ/ÇIKIŞ ÇAPI	1,5"	1,5"	2"	3"	2"	3"	2"
EMME DERİNLİĞİ	7 M	7 M	8 M	8 M	7 M	7 M	7 M
BASMA YÜKSEKLİĞİ	30 M	22 M	30 M	25 M	32 M	30 M	110 M-Kademeli
KAPASİTE	11 M <sup>3</sup> / saat	15 M <sup>3</sup> / saat	34 M <sup>3</sup> / saat	50 M <sup>3</sup> / saat	30 M <sup>3</sup> / saat	50 M <sup>3</sup> / saat	22 M <sup>3</sup> / saat
AĞIRLIK	10 kg	8 kg	23 kg	26 kg	22 kg	24 kg	24 kg



**DAKKIN**

# **BENZİNLİ VE DİZEL JENERATÖRLER**





## LT 3600N

ÜRÜN KODU: 812226

**324 USD**



## LT 3600EN

ÜRÜN KODU: 812227

**389 USD**



MOTOR	GÜÇ	SİLİNDİR HACMİ	TİP	MAKS. GÜÇ/SÜREKLİ GÜÇ
DAKKIN / LT168F-1	6,5 hp	196 cm <sup>3</sup>	Monofaze	2,8 kW - 2,5 kW
GÜÇ ÇIKIŞI	ÇALIŞTIRMA	SÜREKLİ ÇALIŞTIRMA	YAKIT KAPASİTESİ	AĞIRLIK
2xAC(220V) / 1xDC(12V)	İpli-Marşlı	12 saat / 1 Depo	15 L	43 kg

## LT 3900B

ÜRÜN KODU: 812229

**341 USD**



## LT 3900EB

ÜRÜN KODU: 812230

**411 USD**



MOTOR	GÜÇ	SİLİNDİR HACMİ	TİP	MAKS. GÜÇ/SÜREKLİ GÜÇ
DAKKIN / LT170F	7 hp	208 cm <sup>3</sup>	Monofaze	3,0 kW - 2,8 kW
GÜÇ ÇIKIŞI	ÇALIŞTIRMA	SÜREKLİ ÇALIŞTIRMA	YAKIT KAPASİTESİ	AĞIRLIK
2xAC(220V) / 1xDC(12V)	İpli-Marşlı	10 saat / 1 Depo	15 L	45 kg

## LT 8000EN

ÜRÜN KODU: 812228

908 USD



MOTOR	GÜÇ	SİLİNDİR HACMI	TİP	MAKS. GÜÇ/SÜREKLİ GÜÇ
DAKKIN / LT190F	15 hp	420 cm <sup>3</sup>	Monofaze	6,5 kW - 6,0 kW
GÜÇ ÇIKIŞI	ÇALIŞTIRMA	SÜREKLİ ÇALIŞTIRMA	YAKIT KAPASİTESİ	AĞIRLIK
2xAC(220V) / 1xDC(12V)	Marşlı	8 saat / 1 Depo	25 L	85 kg

## LT 10000EN

ÜRÜN KODU: 812322

1009 USD



MOTOR	GÜÇ	SİLİNDİR HACMI	TİP	MAKS. GÜÇ/SÜREKLİ GÜÇ
DAKKIN / LT192	17,4 hp	420 cm <sup>3</sup>	Monofaze	8,3 kW - 8,0 kW
GÜÇ ÇIKIŞI	ÇALIŞTIRMA	SÜREKLİ ÇALIŞTIRMA	YAKIT KAPASİTESİ	AĞIRLIK
2xAC(220V) / 1xDC(12V)	Marşlı	6 saat / 1 Depo	25 L	89 kg

## LT7GF

ÜRÜN KODU: 812232

1334 USD



GÜÇ	VOLTAJ	TİP	ÇALIŞTIRMA	SES SEVİYESİ	SÜREKLİ ÇIKIŞ GÜCÜ
12 hp	230 V / 50 Hz	Monofaze	Marşlı	85 dBA	6,0 kW
MAKS. ÇIKIŞ GÜCÜ	YAKIT	YAKIT KAPASİTESİ	YAKIT KAPASİTESİ	AĞIRLIK	
6,5 kW	Dizel	8 saat / 1 Depo	12,5 L	94 kg	

## LDG8000S

ÜRÜN KODU: 812321

2365 USD



GÜÇ	VOLTAJ	TİP	ÇALIŞTIRMA	SES SEVİYESİ	SÜREKLİ ÇIKIŞ GÜCÜ
13 hp	230 V / 50 Hz	Monofaze	Marşlı	71 dBA	6,0 kW
MAKS. ÇIKIŞ GÜCÜ	YAKIT	YAKIT KAPASİTESİ	YAKIT KAPASİTESİ	AĞIRLIK	
6,5 kW	Dizel	8 saat / 1 Depo	25 L	164 kg	





# DAKKIN

# KAR KÜREME & DAL ÖĞÜTME MAKİNELERİ

## 651Q KAR KÜREME MAKİNESİ

ÜRÜN KODU: 812625

**1211 USD**

MOTOR	LONCIN / 6200F
GÜÇ	6,5 hp - 4,1 kW
SİLİNDİR HACMİ	196 cc
ÇALIŞTIRMA	İpli
HAREKET	5 İleri 2 Geri
BOŞALTMA DÖNÜŞ AÇISI	190 °
ÇALIŞMA GENİŞLİĞİ	56 cm
ÇALIŞMA YÜKSEKLİĞİ	49 cm
PÜSKÜRTME KAPASİTESİ	5 - 15 M
YAKIT	Benzin





## DRGS65S

ÜRÜN KODU: 812701

1255 USD



## DRGS150SH

ÜRÜN KODU: 812702

3028 USD



## DRGSPTO

ÜRÜN KODU: 812703

4975 USD

YENİ

TRAKTÖR ARKASI



### TEKNİK ÖZELLİKLER

ÜRÜN KODU	812703	812702	812701
ÖZELLİKLER	DRGSPTO	DRGS150SH	DRGS65S
GÜÇ	15,0 hp Traktör	15 hp	6,5 hp
SİLİNDİR HACMİ	-	420 cc	196 cc
MOTOR	Traktör Uyumlu	DUCAR	LONCIN
BIÇAK UZUNLUĞU	10 cm Yaprak Bıçak	20 cm	10 cm
ÇALIŞMA GENİŞLİĞİ	15 cm	12,5 cm	5 cm
YAKIT	-	Benzin	Benzin
AĞIRLIK	345 kg	240 kg	85 kg

# ELEKTRİKLİ ÇİT SİSTEMLERİ



AÇIKLAMA	ÜRÜN KODU
SENSÖRLÜ AYARLI ELEKTRİKLİ ÇİT CİHAZI	819920
SENSÖRLÜ AYARLI GÜNEŞ PANELLİ ELEKTRİKLİ ÇİT CİHAZI	819921
ÇİT İPİ 500 METRE EKO	819922
ÇİT İPİ 500 METRE ÇELİK	819923
İZOLATÖR	819924
DEMİR ÇUBUK İZOLATÖRÜ	819925

# KUŞ VE DOMUZ KOVUCU



MEKANİK MODEL	ELEKTRO MEKANİK MODEL	ELEKTRONİK MODEL
ÜRÜN KODU: 991827	ÜRÜN KODU: 991828	ÜRÜN KODU: 991829
Patlatma aralığı 2-20 dakika arasında manuel olarak ayarlanabilir.	Patlatma aralığı 2-25 dakika arasında dijital olarak ayarlanabilir. Ayarlama saati pil ile çalışır. Büyük tüp bağlanabilmesi için ek olarak adaptör takılmalıdır. Büyük tüp (12 kg) ile 32.400 patlama yapabilir. Yağışlı ve rütubetli havalarda dahi çalışır. Küçük tüp (2 kg) ile 5400 patlatma yapabilir.	Patlatma aralığı 2-20 dakika arasında dijital olarak ayarlanabilir. Ayarlama saati şarj edilebilir dahili akü ile çalışır. Büyük tüpe doğrudan bağlanabilir. Küçük tüp adaptörü üründe mevcuttur.



## GC-7A KOYUN KIRPMA MAKİNESİ

ÜRÜN KODU: 819930

123 USD

GÜÇ	DEVİR
350W	2500 Rpm
BIÇAK BOYUTU	NET AĞIRLIK
76 Mm	1,8 kg



## BB25 BİTKİ BAĞLAMA TABANCASI

ÜRÜN KODU: 813720

469 USD

BAĞLAMA ÇAPI	BATARYA	BATARYA KAPASİTESİ
25 Mm	Li-ion	16,8 V / 2 Ah
ŞARJ SÜRESİ	ÇALIŞMA SÜRESİ	AĞIRLIK
1 - 1,5 saat	6 - 8 saat	1,65 kg



## PLASTİK BAĞLAMA İPİ

ÜRÜN KODU: 391624

4,2 EUR



## ÇÖP TOPLAMA APARATLARI

### TIRTIKLI MODEL

ÜRÜN KODU: 811690

12 USD



### DÜZ MODEL

ÜRÜN KODU: 811691

14,7 USD



# ÇAPA MAKİNELERİ

## DAK250

ÜRÜN KODU: 810105

769 USD



1 GERİ, 2 İLERİ



## DAK300

ÜRÜN KODU: 810106

889 USD



1 GERİ, 3 İLERİ



**YENİ**

GÜÇ	ÇAPALAMA DERİNLİĞİ	ÇAPALAMA GENİŞLİĞİ	AKS ÇAPI
7,0 HP	30 CM	60 - 90 CM	27 MM
GİDON	ÇALIŞTIRMA	BIÇAK SAYISI	YAKIT
AYARLI	İPLİ	24 ADET / 6 SIRA	BENZİN

## DAK250 TEKERLEKLI

ÜRÜN KODU: 810107

853 USD

## DAK300 TEKERLEKLI

ÜRÜN KODU: 810108

973 USD



TEKERLEK BOYUTU

4.00 - 8

# HAMUR KARMA MAKİNELERİ

**PASLANMAZ ÇELİK**



KOROZYONA DAYANIKLI  
DEVİRMELİ KAZAN

ULTRA SESSİZ

KİLİTLİ  
TEKERLEKLER

ÜRÜN KODU	819910	819901	819902
ÖZELLİKLER	15 KG	25 KG	35 KG
MOTOR GÜCÜ/VOLTAJ	0,25 kW / 220 V	0,37 kW / 220 V	0,55 kW / 220 V
GÜÇ AKTARIMI	Redüktör	Çift Bıçak	Çift Bıçak
AĞIRLIK	41 kg	47 kg	55 kg



A person wearing a white protective suit and gloves is holding a large basket filled with green and red grapes. The background is a blurred green field. A red rounded rectangle with the word "LISAM" in white is overlaid on the image.

**LISAM**

# FİLİZ KIRMAYAN MAKİNE BİR SENE DEĞİL HER SENE ZEYTİN!

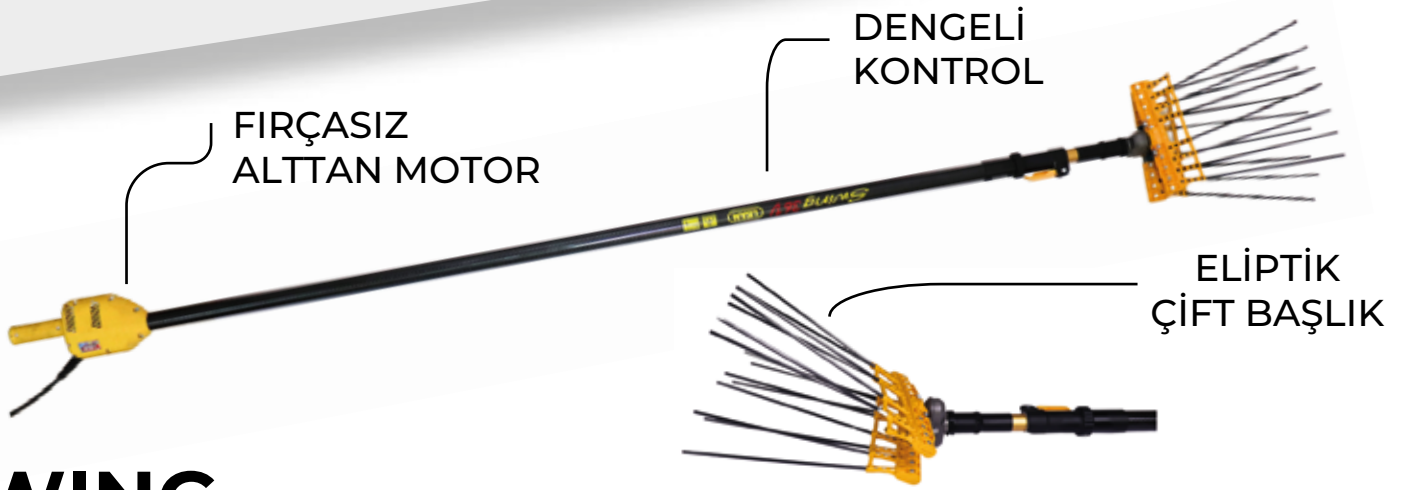

## SWING

ÜRÜN KODU	VOLTAJ	TİP	VURUŞ/DK	AĞIRLIK	UZUNLUK	FİYAT
395770	12V	SENSÖRSÜZ	1200	3,0 KG	2,45 - 3,50 KG	1124 EUR
395771	36V	SENSÖRSÜZ	1380	3,0 KG	2,45 - 3,50 KG	1287 EUR
395772	36V	SENSÖRLÜ	1380	3,0 KG	2,45 - 3,50 KG	1312 EUR

Toplama sistemli ve eliptik hareketli çift taraflı profesyonel silkeleyici tarak. 36 Volt fırçasız motor. Çok kalın dallara bile derinlemesine nüfuz etmenizi sağlayan değiştirilebilir ve uzun karbon çubuklar. Maksimum iş üretimini garanti eden tarak. 15 metre elektrik kablosu birlikte verilir.

**YENİLENDİ**



## OLIWATT 3

ÜRÜN KODU:395769 **1338 EUR**

VOLTAJ	VURUŞ/DK	AĞIRLIK	UZUNLUK
12V	1300	2,5 KG	2,40 - 3,30 M



## SNAKE

ÜRÜN KODU:395768 **240 EUR**

VOLTAJ	VURUŞ/DK	AĞIRLIK	UZUNLUK
12V	1100	2,2 KG	2,20 - 3,20 M

## SLY

ÜRÜN KODU	KESME ÇAPI	BAR	TÜKETİM	AĞIRLIK	FİYAT
393628	30 MM	8-10	80 LT/DK	550 GR	257 EUR

Profesyonel budama için tasarlanmış bu pnömatik makas, kiraz, kayısı, şeftali ve elma ağaçları için mükemmel bir budama sunar.



## SLY RAPID KOLAY BAĞLANTI

ÜRÜN KODU:393629 **289 EUR**

## SLY ASTA VİDALI BAĞLANTI

ÜRÜN KODU:393630 **289 EUR**

## SLY DT

ÜRÜN KODU	KESME ÇAPI	BAR	TÜKETİM	AĞIRLIK	FİYAT
393632	30 MM	8-10	80 LT/DK	550 GR	316 EUR

Çift kenarlı bıçaklara sahip pnömatik makas, dalın iyileşmesine yardımcı olan hassas budama için.



## SUPER SLY

KESME ÇAPI	BAR	TÜKETİM	AĞIRLIK
40 MM	8-10	90 LT/DK	800 GR

En yüksek dalları güvenli bir şekilde ve merdiven zahmetine girmeden budamak için uzatma çubuklu pnömatik makas.

## SUPER SLY RAPID KOLAY BAĞLANTI

ÜRÜN KODU:393633 **375 EUR**

## SUPER SLY ASTA VİDALI BAĞLANTI

ÜRÜN KODU:393634 **305 EUR**



## 4WIN

ÜRÜN KODU	KESME ÇAPI	BAR	TÜKETİM	AĞIRLIK	FİYAT
393631	30 MM	8-10	80 LT/DK	550 GR	289 EUR

Uzatılmış bıçaklara sahip pnömatik makas, asma budaması için özel olarak tasarlanmıştır.



## VR36

ÜRÜN KODU	KESME ÇAPI	BAR	TÜKETİM	AĞIRLIK	FİYAT
393627	30 MM	8-10	80 LT/DK	600 GR	268 EUR

Çift pistonlu pnömatik makas. 30 mm çapı 30mm çapı ve ince gövəsi sayesinde küçük elli operatörler için bile son derece konforludur.





## 2/SP 10"/4

ÜRÜN KODU	KILAVUZ	BAR	TÜKETİM	AĞIRLIK	FİYAT
391035	20 CM	8-10	400-430 LT/DK	2,0 KG	669 EUR

Çapı 20 cm'ye kadar olan dalları budamak için. Verimli, güvenli ve etkili budama için bir testere serisi olan 2SP'nin zincirli, sivri uçlu ve geleneksel çubuklu modelleri mevcuttur.



## SKYMAN/10"

ÜRÜN KODU	KILAVUZ	BAR	TÜKETİM	AĞIRLIK	FİYAT
391036	20 CM	8-10	400-430 LT/DK	1,9 KG	669 EUR

Bu hafif bir alettir ve son derece yönetilebilirdir, çünkü ergonomik biçimi operatörlerin daha rahat çalışmasını sağlamak için incelenmiştir. Küçük ve ince, en zorlu budama manevraları sırasında bile kullanımı çok kolaydır.



## MG TURBO

ÜRÜN KODU	BAR	TÜKETİM	AĞIRLIK	FİYAT
395637	6	160 LT/DK	1000 GR	653 EUR

Magnezyum gövdeli pnömatik tarak. Alternatif şaftlı tarakların ucu, bitkiye zarar gelmesini önlemek için yuvarlatılmıştır. Bu hafif versiyon, üretkenliği artıran ve ağırlığı azaltan hafifletilmiş taraklara sahiptir.



## V8 KARBON

ÜRÜN KODU	BAR	TÜKETİM	AĞIRLIK	FİYAT
395638	6	160 LT/DK	800 GR	696 EUR

Karbon, magnezyum ve teknopolimer bileşenli hasat tarağı. Dalların hasar görmesini önlemek için ucu kapalı, değiştirilebilir karbon çubuklar. Yüksek verimlilik.



## R8 KARBON

ÜRÜN KODU	BAR	TÜKETİM	AĞIRLIK	FİYAT
395639	6	160 LT/DK	790 GR	690 EUR

Yanal hareketli ve çok uzun karbon çubuklu hasat tarağı. Kalın dallara nüfuz etmek için idealdir.



## KARBON HAFİF UZATMA BORUSU

ÜRÜN KODU	MODEL	AĞIRLIK	FİYAT
391640	EL/100 MT - 1,00	460 GR	182 EUR
391641	EL/150 MT - 1,50	620 GR	184 EUR
391642	EL/200 MT - 2,00	726 GR	187 EUR
391643	EL/250 MT - 2,50	855 GR	198 EUR
391644	EL/300 MT - 3,00	990 GR	212 EUR



## ALÜMİNYUM TETİKLİ UZATMA BORUSU

ÜRÜN KODU	MODEL	AĞIRLIK	FİYAT
391645	PR/05 MT - 0,50	690 GR	177 EUR
391646	PR/100 MT - 1,00	900 GR	201 EUR
391647	PR/150 MT - 1,50	1100 GR	223 EUR
391648	PR/200 MT - 2,00	1270 GR	234 EUR
391649	PR/250 MT - 2,50	1530 GR	250 EUR
391650	PR/300 MT - 3,00	1720 GR	278 EUR



## TELESKOPIK UZATMA BORUSU

ÜRÜN KODU	MODEL	AĞIRLIK	FİYAT
391651	AT01 MT / 1,00 - 1,50	1170 GR	278 EUR
391652	AT02 MT / 1,45 - 2,25	1390 GR	306 EUR
391653	AT03 MT / 1,85 - 3,10	1690 GR	362 EUR
391654	AT04 MT / 2,50 - 4,00	2000 GR	389 EUR



## BENZİNLİ KOMPRESÖRLER

ÜRÜN KODU	MODEL	MOTOR GÜCÜ	ALINAN HAVA (L/DK)	TANK KAPASİTESİ	MAX. BASIÇ (BAR)	AĞIRLIK	BOYUT (CM)	MAKAS KAPASİTESİ	ZEYTİN SİLKİCİ KAPASİTESİ	TESTERE KAPASİTESİ	FİYAT
395556	LM 300/10	4 HP	300 L	10 L	9-11	42 KG	81x51x60	2-3 ADET	1 ADET	2-3 ADET	1926 EUR
395557	LM 500/10	5,5 HP	500 L	10 L	9-11	40 KG	87x62x58	3-4 ADET	2-3 ADET	3-4 ADET	2515 EUR
395558	LM 600/30	6,5 HP	600 L	11+11 L	9-11	95 KG	87x70x81	5 ADET	5 ADET	5 ADET	3050 EUR
395559	LM 998/40	13 HP	998 L	10+10 L	9-11	135 KG	77x98x96	9 ADET	5-6 ADET	9 ADET	4467 EUR



### 9110 HORTUM MAKARASI

ÜRÜN KODU: 391660

203,5 USD



### X2901 100M HORTUM

ÜRÜN KODU: 391761

247,5 USD

## TRAKTÖR ARKASI KOMPRESÖRLER

ÜRÜN KODU	MODEL	ALINAN HAVA (L/DK)	TANK KAPASİTESİ	MAX. BASIÇ (BAR)	AĞIRLIK	BOYUT (CM)	MAKAS KAPASİTESİ	ZEYTİN SİLKİCİ KAPASİTESİ	TESTERE KAPASİTESİ	FİYAT
395562	ECOLINE 600	600 L	20 L	9-11	99 KG	58x78x83	6 ADET	3 ADET	1 ADET	2943 EUR
395563	ECOLINE 998	998 L	20 L	9-11	116 KG	58x78x83	9 ADET	5-6 ADET	1-2 ADET	3183 EUR
395564	ECOLINE 1500	1500 L	20 L	9-11	160 KG	70x85x90	14 ADET	7 ADET	2 ADET	4521 EUR





## LM012 OLIVE KIT

ÜRÜN KODU: 396065

**3103 EUR**



## LM032 OLIVE HOBBY KIT

ÜRÜN KODU: 396066

**4762 EUR**



## LM032 OLIVE HOBBY KIT

ÜRÜN KODU: 396067

**9363 EUR**



## ÇİFT AĞIZLI DÖVME ÇELİK

ÜRÜN KODU	KESME ÇAPI	BOYUT	AĞIRLIK	FİYAT
393811	2,5 CM	19 CM	300 GR	61 EUR
393812	2,5 CM	21 CM	335 GR	61 EUR

-Çift ağızlı bıçaklı budama makası

-Dalda kalıntı bırakmayan budama için temiz ve hassas kesim

-Manuel şekilde çift kesim sağlayan bıçaklar dalın merkezinde buluşur, böylece gereken çabayı azaltır ve dalın hızlı iyileşmesini sağlar.



## TYTRON KALIN DAL MAKASI

ÜRÜN KODU	KESME ÇAPI	BOYUT	AĞIRLIK	FİYAT
393913	4,5 CM	50 CM	855 GR	141 EUR
393914	4,5 CM	80 CM	1060 GR	148 EUR
393915	4,5 CM	100 CM	1186 GR	156 EUR

-Çift ağızlı bıçaklı budama makası.

-Dalda kalıntı bırakmayan budama için temiz ve hassas kesim

-Tytron, budama işinde operatörü yormayan, çift menteşeli kollu son nesil dal kesme makasıdır.

-Ortaya çıkan kesim mükemmel derecede temizdir.



## KALIN DAL MAKASI

ÜRÜN KODU	KESME ÇAPI	BOYUT	AĞIRLIK	FİYAT
393916	4,5 CM	50 CM	923 GR	98 EUR
393917	4,5 CM	80 CM	1060 GR	105 EUR
393918	4,5 CM	100 CM	1256 GR	114 EUR

-Sayısız çiftçinin elinde onlarca yıldır kullanımla kanıtlanmış geleneksel dal kesme makinesi, sağlam, dayanıklı ve güvenilirdir.

-5 cm'ye kadar kesim yapabilme özelliğine sahiptir.

-50, 80 ve 100 cm versiyonları mevcuttur.



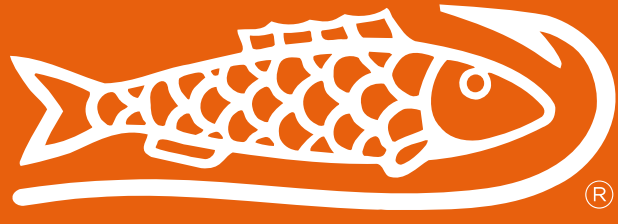

**BAHCO**

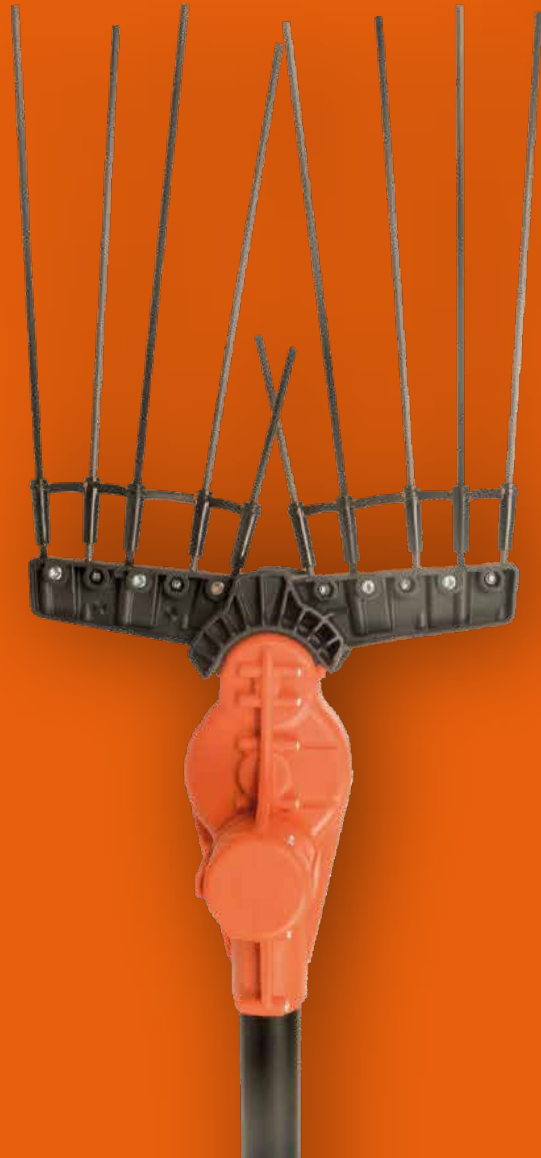

MANSTAN ALIR  
GÜCÜNÜ PERF  
MANSTAN ALIR  
GÜCÜNÜ PERF





## BCL52TP TELESKOPİK 36V ZEYTİN HASAT MAKİNESİ

1125,00 EUR

Ürün Kodu : 295701



WATT	VOLTAJ	ÇUBUK ADET	UZUNLUK	AĞIRLIK
700	36	10	330mm 950bpm	2200 mm 2250

- Gün boyu büyük kolaylık ve hassasiyetle çalışırken zeytin hasadında verimliliği en üst düzeye çıkarın
- Bu alet mükemmel bir denge-ağırlık oranına sahiptir, oldukça hafif 2.250 g ağırlığıyla kullanımında minimum titreşim sağlar
- 2,16 m – 2,96 m boyunda karbon fiber Teleskopik Uzatma Çubuğu
- 330 mm'lik 10 esnek karbon fiber çubuk
- 600 mm çalışma aralıklı martı kanadı şeklinde - zıt hareketli iki tarak
- Kullanılan saat sayısını ve hız seviyesini gösteren Akıllı ekran, dakikada 950 ile 1.200 devir arasında 5 farklı hız seçme özelliği
- Hem sol hem de sağ el kullanımı için uygun makine

## BCL52FP SABİT 36V ZEYTİN HASAT MAKİNESİ

1050,00 EUR

Ürün Kodu : 295702



WATT	VOLTAJ	ÇUBUK ADET	UZUNLUK
370	36	10	330mm 950bpm 2200 mm

- Tüm gün büyük kolaylık ve hassasiyetle çalışırken zeytin hasadında verimliliği en üst düzeye çıkarın
- Yüksek verimli fırçasız motor 700 W
- Karbon fiberden yapılmış Uzatma Çubuğu 2.500 mm uzunluğundadır ve 700 mm Alüminyum uzatmaya sahiptir 330 mm'lik
- 10 Esnek karbon fiber çubuk
- Martı kanadı şeklinde zıt hareketli iki tarak, 600 mm çalışma aralığındadır
- Kullanılan saat sayısını ve hız seviyesini gösteren Akıllı ekran, dakikada 950 ile 1.200 devir arasında 5 farklı hız seçme özelliği
- Daha iyi kavrama için güçlü ve dayanıklı tasarıma sahip tutamak
- Hem sol hem de sağ el kullanımı için uygun makine

## BCL51 SABİT 12V ZEYTİN HASAT MAKİNESİ

840,00 EUR

Ürün Kodu : 295703



VOLTAJ	ÇUBUK ADET	UZUNLUK	AĞIRLIK
12	10	275mm 1650bpm	2200 mm 2200

- Zeytin hasadında gün boyunca hasat makinesiyle çalışın
- Zeytin hasat makinemiz iyi bir denge/ağırlık oranına sahiptir
- Alüminyum Uzatma Çubuğu uzunluğu 2.300 mm olup 1000 mm daha uzatılabilmektedir
- 8 adet 272 mm uzunluğunda ve 2 adet 120 mm uzunluğunda toplam 10 esnek karbon fiber çubuk
- 400 mm çalışma aralığında zıt hareketli iki tarak
- Rahat tutma yerine sahip güçlü ve dayanıklı tasarım
- Hem sol hem de sağ el kullanımına uygun tek tutamak
- 14m Uzatma kablolu BCL5115, hızlı konektör ile 12V bağlamak için pozitif ve negatif kısıkaç - lar ve batarya dahildir

## BCL52CNV 12V DÖNÜŞTÜRÜCÜ

245,00 EUR



ÜRÜN KODU	V <sub>in</sub>	V <sub>out</sub>	mm		
BCL52CNV	296501	35	1296	147	8-10H 880



## BCL23 AKÜLÜ BUDAMA MAKASI

1627,00 EUR



Yedek Parça Mevcut



Uzun Pil Ömür



Lityum Batarya



2 Yıl Garanti

Kesme Kapasitesi	35 mm
Ağırlık	880 g
Uzunluk	280 mm
Çalışma modları	2
Elektronik bıçak ayarı	✓
Motor soğutma sistemi	✓
Kılıf	✓
BCL1B1 batarya sensör (standart satılır)	8-10saat kadar

ÜRÜN KODU	W	Ah	Wh	mm	g				
BCL23	293723	35	1296	3,4	147	1050	8-10H	280	880



### BCL2B1 Batarya Teknik Bilgileri

Ağırlık (donanım veya kemer olmadan)	845 g
Tip	Li-ion
Voltaj	43,2 V
Kapasite	3,45 Ah
Depolanan Enerji	150 Wh
Maksimum güç	865 W
Ortalama ömür süresi – Şarj döngüleri	800
Şarj süresi	9 h
BCL1C0 - şarj cihazı 0,4 A	✓
Batarya ile tedarik edilen standart donanım	BCL22HKemer

- Yüksek kaliteli krom kaplamalı SK5 Japon çelik bıçak: Keskinliği korur, sürtünmeyi azaltır ve aşınmaya ve paslanmaya karşı mükemmel derecede dayanıklıdır.
- Yüksek verimli fırçasız motor.
- Daha iyi kavrama ve konfor için kaymaz yumuşak sap.
- Bıçak hareketini kontrol etmek için hassas kademeli tetik.
- Hızlı ve etkili budama için 23 mm'lik veya yoğun ve güçlü budama için 35 mm'lik çift bıçak açıklığı.
- Kullanıldığında kolay saklama için çıkarılabilir köpük içeren sert bir kutu içinde tedarik edilir.
- BCL2B1 pil, BCL2C1 şarj cihazı, BCL2HOL koruyucu kılıf, BCL2BE kayış, BCLAB kolluk, BCL2GR gres ve aletler dahildir.
- Sağlam ve dayanıklı tasarım.
- Tüm gün büyük bir kolaylıkla ve hassas biçimde çalışır, yoğun bir şekilde asma budaması için idealdir.
- Güçlü kesimler, yüksek konfor ve hassasiyet ile olağanüstü kesme gücü sayesinde etkin verimli bir şekilde budama yapmanızı sağlar.
- Bakım kapağı erişimi ile kolay bıçak değişimi ve ayarı.
- Kolay bakım için yağlama deliği ve somun kilit sistemi.
- Sol veya sağ elini kullanan kullanıcılar için uygun bir alet.



## BCL24 AKÜLÜ BUDAMA MAKASI

1965,00 EUR



Yedek Parça Mevcut



Uzun Pil Ömür



Lityum Batarya



2 Yıl Garanti



<b>Kesme Kapasitesi</b>	45 mm
<b>Ağırlık</b>	1,020 g
<b>Uzunluk</b>	295 mm
<b>Çalışma modları</b>	2
<b>Elektronik bıçak ayarı</b>	✓
<b>Motor soğutma sistemi</b>	✓
<b>Kılıf</b>	✓
<b>BCL1B1 batarya sensör (standart satılır)</b>	8-10saat kadar

	<b>ÜRÜN KODU</b>		<b>W</b>	<b>Ah</b>	<b>Wh</b>			<b>mm</b>	
BCL24	293724	45	1512	6,8	294	1900	8-10H	295	1020



### BCL2B2 Batarya Teknik Bilgileri

<b>Ağırlık (donanım veya kemer olmadan)</b>	1900 g
<b>Tip</b>	Li-ion
<b>Voltaj</b>	43,2 V
<b>Kapasite</b>	6,8 Ah
<b>Depolanan Enerji</b>	294 Wh
<b>Maksimum güç</b>	1512 W
<b>Ortalama ömür süresi – Şarj döngüleri</b>	1000
<b>Şarj süresi</b>	3,3 h
<b>BCL1C0 - şarj cihazı 0,4 A</b>	✓
<b>Batarya ile tedarik edilen standart donanım</b>	BCL22HKemer

• Yüksek kaliteli krom kaplamalı SK5 Japon çelik bıçak: Keskinliği korur, sürtünmeyi azaltır ve aşınmaya ve paslanmaya karşı mükemmel derecede dayanıklıdır.

• Yüksek verimli fırçasız motor.

• Daha iyi kavrama ve konfor için kaymaz yumuşak sap.

• Bıçak hareketini kontrol etmek için hassas kademeli tetik.

• Hızlı ve etkili budama için 30 mm'lik veya yoğun ve güçlü budama için 45 mm'lik çift bıçak açıklığı.

• Kullanıldığında kolay saklama için çıkarılabilir köpük içeren sert bir kutu içinde tedarik edilir.

• BCL2B2 pil, BCL2C1 şarj cihazı, BCL2HOL kılıf, BCL20H emniyet kemeri, BCLAB kolluk, BCL2GR gres ve aletler dahildir.

• Başta çekirdekli meyveleri budarken kalın ve son derece sert ağaçları kolayca kesebilirsiniz, zeytin, narenciye ve yemiş ağaçları.

• Son derece güçlü kesme gücü, olağanüstü sert ağaçlarda bile doğru kesimlere olanak sağlayan çok temiz bir kesim yüzeyi.

• Bakım kapağı erişimi ile kolay bıçak değişimi ve ayarı.

• Kolay bakım için yağlama deliği ve somun kilit sistemi.

• Sol veya sağ elini kullanan kullanıcılar için uygun bir alet.



## BCL226 AKÜLÜ BUDAMA MAKASI

378,00 EUR

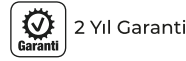

### Farklı budama gereksinimleri için 2 kademeli kesim açısı



1. Kesim Açısı:  
15 mm



2. Kesim Açısı:  
26 mm

ÜRÜN KODU	W	Ah	Wh	g	mm	g			
BCL226	293701	26	400	2,5	27	190	1,5H	290	920



Kesme Kapasitesi	26 mm
Ağırlık	920 g
Uzunluk	290 mm
Elektronik bıçak ayarı	✓
Motor soğutma sistemi	✓
Yedek Batarya ile Çalışma süresi	6 saat kadar



### Batarya Teknik Bilgileri

Ağırlık	190 g
Tip	Li-ion
Voltaj	12,6 V
Kapasite	2,5 Ah
Depolanan Enerji	27 Wh
Maksimum güç	400 W
Şarj süresi	1,5 h
Şarj cihazı	✓

- Bağ, çalimsı bitkiler ve küçük ağaçların budaması için.
- İsteğe göre ayarlanabilen 2 bıçak açıklığı ile aşamalı kesim.
- Budama işleminde rahatlık için dahili pil.
- Rahat kullanım ve sağlamlık için güçlendirilmiş plastikten yapılmış uzun gövde ile mükemmel kavrama.
- Çift batarya ile 6 saate kadar kullanım imkanı.
- Yağlama noktası ile somun kilit sistemi olan merkezi civata kolay bakım ve ayar imkanı.
- Akıllı ekran kesme sayısını ve pil doluluk düzeyini gösterir.



### İLAVE BATARYA

52,00 EUR

Ürün Kodu: 291617



## BCL235 AKÜLÜ BUDAMA MAKASI

504,00 EUR



Lityum Batarya



2 Yıl Garanti



Farklı budama gereksinimleri için 2 kademeli kesim açısı



1. Kesim Açısı:  
18 mm



2. Kesim Açısı:  
35 mm

ÜRÜN KODU	W	Ah	Wh	g	mm	g			
BCL235	293702	35	500	2,5	36	230	1,5H	285	970



Kesme Kapasitesi	35 mm
Ağırlık	970 g
Uzunluk	285 mm
Elektronik bıçak ayarı	✓
Motor soğutma sistemi	✓
Yedek Batarya ile Çalışma süresi	6 saat kadar

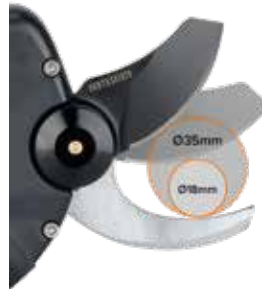

### Batarya Teknik Bilgileri

Ağırlık	230 g
Tip	Li-ion
Voltaj	14,4 V
Kapasite	2,5 Ah
Depolanan Enerji	36 Wh
Maksimum güç	500 W
Şarj süresi	1,5 h
Şarj cihazı	✓

- Bağ, çalimsı bitkiler ve küçük ağaçların budaması için.
- İsteğe göre ayarlanabilen 2 bıçak açıklığı ile aşamalı kesim.
- Budama işleminde rahatlık için dahili pil.
- Rahat kullanım ve sağlamlık için güçlendirilmiş plastikten yapılmış uzun gövde ile mükemmel kavrama.
- Çift batarya ile 6 saate kadar kullanım imkanı.
- Yağlama noktası ile somun kilit sistemi olan merkezi civata kolay bakım ve ayar imkanı.
- Akıllı ekran kesme sayısını ve pil doluluk düzeyini gösterir.



### İLAVE BATARYA

157,00 EUR

Ürün Kodu: 291615



## BCL240 AKÜLÜ BUDAMA MAKASI

693,00 EUR



Lityum Batarya



2 Yıl Garanti



Farklı budama gereksinimleri için 2 kademeli kesim açısı



1. Kesim Açısı:  
27 mm



2. Kesim Açısı:  
40 mm

ÜRÜN KODU	W	Ah	Wh	g	mm	g			
BCL240	293703	40	850	2,5	54	345	2,5H	290	1230



Kesme Kapasitesi	40 mm
Ağırlık	970 g
Uzunluk	285 mm
Elektronik bıçak ayarı	✓
Motor soğutma sistemi	✓
Yedek Batarya ile Çalışma süresi	6 saat kadar



### İLAVE BATARYA

191,00 EUR

Ürün Kodu: 291616

- Bağ, çalimsı bitkiler ve küçük ağaçların budaması için.
- İsteğe göre ayarlanabilen 2 bıçak açıklığı ile aşamalı kesim.
- Budama işleminde rahatlık için dahili pil.

### Batarya Teknik Bilgileri

Ağırlık	230 g
Tip	Li-ion
Voltaj	14,4 V
Kapasite	2,5 Ah
Depolanan Enerji	36 Wh
Maksimum güç	500 W
Şarj süresi	1,5 h
Şarj cihazı	✓

## BCL25TP TELESKOPIK SAP

319,00 EUR



- BCL240 budama makasları, daha yükseğe erişim gerektiğinde BCL25TP teleskopik sapa kolayca takılabilir.
- 4,3 m'ye kadar ulaşılması zor alanlarda çalışırken güvenlikten ödün vermeden daha yükseğe erişin.
- Kolay bağlantı sistemine sahip budama makası koruyucu kılıfı.
- Daha iyi kavrama ve konfor için kaydırmaz yumuşak sap.
- Teleskopik kilitleme mekanizması.
- Alüminyum çubuk.

ÜRÜN KODU	mm	g	
BCL25TP	291601	220	1230





## TELESKOPIK TEPE BUDAMA MAKASI

138,00 EUR

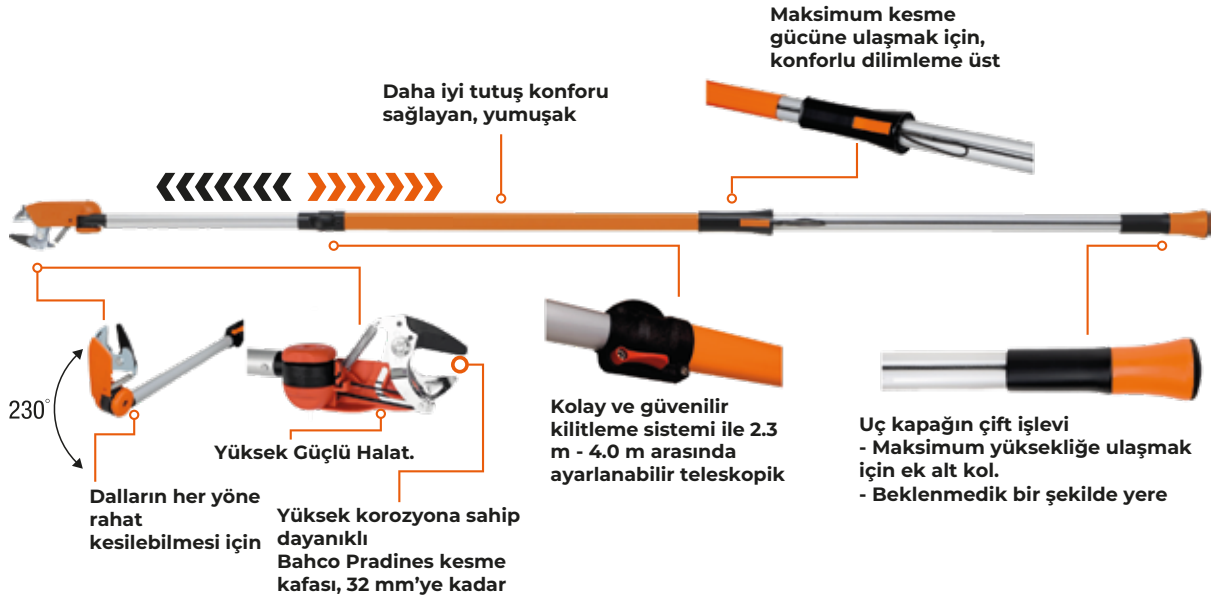

• Ekstra sertleştirilmiş kesici bıçağıyla teleskopik tepe budama makası. 230 derecelik açıda ayarlanabilir kafa.

• Teleskopik gövde uzunluğu 2,30 m'den 4,10 m'ye ayarlanabilir kolay ve güvenilir kilitleme sistemi. Yeşil ve kuru dallar için uygundur.

• Halatın gerginliğini ayarlama

ÜRÜN KODU	mm	9	2
ATP-230-410	294011	32	2370-4110
1950			





## SABİT TUTAMAKLI ERGONOMİK BUDAMA MAKASI



ÜRÜN KODU	15	20	30	S	M	L	FİYAT
PX-S1	293811	15	S	308	2	80 EUR	
PX-S2	293812	20	S	296	2	80 EUR	
PX-M1	293813	15	M	322	2	80 EUR	
PX-M2	293814	20	M	319	2	80 EUR	
PX-M2-L	293815	20	M	319	2	80 EUR	
PX-M3	293816	30	M	347	2	80 EUR	
PX-L2	293817	20	L	331	2	80 EUR	
PX-L3	293818	30	L	470	2	80 EUR	

- Bilimsel ERGO™ süreçlerine uygun geliştirilmiş makaslar.
- Tutamağın şekli ve ölçüsü elinize adapte olur.
- Kesici başın ölçüsü uygulanacak işe göre ayarlanmıştır.
- Kesici başın dikey ve yan eğimleri budamayı düz bir bilekle yapmanıza izin verir.
- Yorgunluk ve acıyı azaltır, rahatlık ve performans sağlar.
- PX tutamaklar, üstünde yumuşak plastik bileşim den yapılmıştır.
- Üç farklı ebadı vardır: S ( küçük ), M ( orta ), L (büyük).
- Üç değişik ölçüde kesme kafası vardır: 1 (15mm, 1/2"), 2 (20mm, 3/4") ve 3 (30mm, 1 1/4").
- Tüm kesici ağızlar tüm tutamaklara uyar.
- PX-M2-L sol el için budama makasıdır.

## DÖNER TUTAMAKLI ERGONOMİK BUDAMA MAKASI

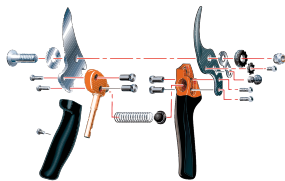

ÜRÜN KODU	15	20	30	S	M	L	FİYAT
PXR-S1	293819	15	S	366	2	107 EUR	
PXR-S2	293820	20	S	377	2	107 EUR	
PXR-M1	293821	15	M	284	2	107 EUR	
PXR-M2	293822	20	M	394	2	107 EUR	
PXR-M2-L	293823	20	M	394	2	107 EUR	
PXR-M3	293824	30	M	407	2	107 EUR	
PXR-L2	293826	30	L	395	2	107 EUR	

- Bilimsel ERGO™ süreçlerine uygun geliştirilmiş makaslar.
- PXR, PX modeli gibi olup yumuşak malzeme kaplı döner tutamağa sahiptir.
- Döner sap, performansı artırır. Üç değişik ölçüde PXR sapı mevcuttur. Profesyonel kullanım için tasarlanmıştır.
- Üç farklı ebadı vardır: S ( küçük ), M ( orta ) ve L (büyük).
- Üç değişik ölçüde kesme başı mevcuttur: 1 (15mm, 1/2"), 2 (20mm, 3/4") and 3 (30mm, 1 1/4").
- Tüm kesme başları tüm tutamaklara uyar.
- PXR-M2-L sol el için budama makasıdır.

## SABİT TUTAMAKLI MEYVE BUDAMA MAKASI

71,00 EUR



ÜRÜN KODU	mm	g
P4-20 293827	22 200	234 4

- Meyve ve narenciye ağaçlarının sert dallarının budamasında hassas ve etkili kesim yaparak budama verimliliğinin artırır.
- Güçlendirilmiş bıçak sert çekirdekli, narenciye ve diğer meyve ağaçlarının etkili budaması için uygundur.
- Uzun ömürlü lazer ile bilenmiş bıçaklar.
- Tek el kilitleme mekanizması.
- Daha iyi kavrama için kaymaz ve sabit tutamak.
- Aşınmaya dayanıklı.

## P4-20 & PROF-H DERİ KILIF

78,00 EUR

Ürün Kodu:293810



## DÖNER TUTAMAKLI MEYVE BUDAMA MAKASI

96,00 EUR



ÜRÜN KODU	mm	g
P4R-20 293828	22 200	303 4

- Meyve ve narenciye ağaçlarının sert dallarının budamasında hassas ve etkili kesim yaparak budama verimliliğinin artırır.
- Güçlendirilmiş bıçak sert çekirdekli, narenciye ve diğer meyve ağaçlarının etkili budaması için uygundur.
- Uzun ömürlü lazer ile bilenmiş bıçaklar.
- Tek el kilitleme mekanizması.
- Daha iyi kavrama için kaymaz ve döner tutamak.
- Aşınmaya dayanıklı.

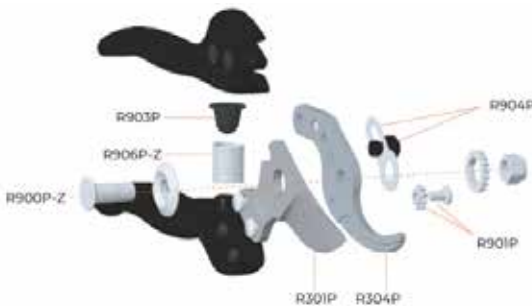





## PG-12 MAKAS



ÜRÜN KODU	mm	g	FİYAT
PG-12-F 293829	20 210	165	10 19,6 EUR
PG-12-BULK15 293830	20 210	165	15 294 EUR

- Rahat kompozit tutamak.
- Dar kesme kafasıyla daha kolay erişim.
- Tam sertleştirilmiş çentikli çelik kesme kafası.
- Tek elle kilitleme mekanizması.

## PG-01/03BUDAMA MAKASI



ÜRÜN KODU	mm	g	FİYAT
PG-01-F 293831	12-20 200	220	6 35 EUR
PG-03-L 293832	12-20 200	220	2 39 EUR

- Bahçede tüm budama işlemleri için uygundur.
- Küçük ve büyük eller için uygundur.
- Fibreglass plastik kol, tek el kilit mekanizması.

## P1 KOPMOZİT TUTAMAKLI BUDAMA MAKASI



ÜRÜN KODU	mm	g	FİYAT
P1-20 293837	20 200	225	5 61 EUR
P1-23 293838	30 230	255	5 65 EUR

- Bağ, meyve bahçeleri ve dekoratif bahçelerin budanması için.
- Yüksek performans için dilimleyerek kesim ve hassas taşlanmış bıçaklar.
- Rahat biçime sahip kompozit tutamaklar.
- Tek elle kilitleme mekanizması.

## P5 BUDAMA MAKASI, DÖVME ÇELİK



ÜRÜN KODU	mm	g	FİYAT
P5-23-F 293840	20 230	366	2 78 EUR

- Genel budama için geleneksel budama makası.
- Sağlam dizayn ve dövme kollar, rahat tutuş.
- Dar ve ters bıçak, sık bitkilerin iç dallarına erişimi sağlar.
- Tek tokalı tek elle kilitleme mekanizması.



## P3 BUDAMA MAKASI



ÜRÜN KODU	mm	g	FİYAT
P3-20-F 293876	20	200	375 2 73 EUR
P3-23-F 293877	25	230	230 2 79 EUR

- Bağıcılık için budama ve şekil vermede kullanılan geleneksel tasarımlı budama makası. Geniş kesme başı, genel budamalar için.
- Tamamen sertleştirilmiş çelik bıçak. Sağlam ve dökme kollar.
- Yedek parça mevcuttur.

## P64 BUDAMA MAKASI



ÜRÜN KODU	mm	g	FİYAT
P64-20 293841	12	210	175 6 53 EUR
P64-20-BULK12 293842	12	210	2520 12 636 EUR

- Kompozit malzemeden, özellikle gül ve çiçek kesimi için uygundur.
- Özel tasarım bıçak kesimden sonra çiçeğin düşmesini engeller.
- Tek ya da 12'li setler halinde sunulmaktadır.
- Yay ve tampon yedek parça olarak mevcuttur.

## P108 BUDAMA MAKASI



ÜRÜN KODU	mm	g	FİYAT
P108-20-F 293843	20	200	305 2 60 EUR
P108-23-F 293844	25	230	375 2 63 EUR

- Bahçe ağaçlarında ve şekil vermede kullanılan budama makası
- Kolay ulaşım için daha dar kesme başı.
- Tek elle kilitleme mekanizması.

## P110 BUDAMA MAKASI



ÜRÜN KODU	mm	g	FİYAT
P110-20-F 293845	20	200	315 2 53 EUR
P110-23-F 293846	25	230	390 2 57 EUR

- Bağıcılık için budama makası.
- Kolay ulaşım için dar kesme başı.
- Tamamen sertleştirilmiş çelik bıçak.
- Pres ve dövme çelik kollar.

## P121 BUDAMA MAKASI



ÜRÜN KODU	mm	g	FİYAT
P121-18-F 293847	15	180	225 6 38 EUR
P121-20-F 293848	20	200	225 6 42 EUR
P121-23-F 293849	25	230	230 6 43 EUR

- Tüm budama işleriniz için kullanılabilen budama makası.
- Kolay ulaşım için dar kesme başı, Dövme ve sıkılaştırılmış çelik kollar.

## P126 BUDAMA MAKASI



ÜRÜN KODU	mm	g	FİYAT
P126-19-F 293850	15	190	245 6 35 EUR
P126-22-F 293851	25	220	310 6 39 EUR

- Genel amaçlı bahçecilik için geleneksel tasarım ve güçlü makas.
- Kollar dövme ve sıkılaştırılmış çelik.
- Tel tokalı kilitleme mekanizması.
- Yedek paça mevcut değil.

## P138 BUDAMA MAKASI

47,00 EUR



ÜRÜN KODU	mm	g	FİYAT
P138-22-F 293853	20 220	275	6

- Sert ve kuru dal kesimi için örs tipi makas.
- Preslenmiş, yüksek kesim kapasitesi, tamamen güçlendirilmiş.
- Ekstra sertleştirilmiş alüminyum örs.
- Tel tokalı, preslenmiş çelik tutamaçlar. Yedek parça mevcuttur

## P123 HASAT MAKASI



ÜRÜN KODU	mm	g	FİYAT
P123-19 293878	10 190 87	1	16 EUR
P123-19-BULK15 293854	10 190 87	15	240 EUR
P123-19-BULK30 293855	10 190 87	30	480 EUR
P123-19-BULK56 293856	10 190 87	56	896 EUR

- Üzüm ve diğer meyveler, çiçek ve bazı sebzeler için hasat makası.
- Makaslar BULK30 kutuda kılıflı, BULK56 kılıfsızdır.

## P127 HASAT MAKASI



ÜRÜN KODU	mm	g	FİYAT
P127-19-BULK30 293857	6 170 70	1	18,4 EUR

- Hasat ve çiçekçilik için kullanılan çok kullanışlı ve hafif makas.
- İnce telleri kesebilme özelliği.
- 30 adet hafif plastik kutuda sunulmuştur.

## P128 HASAT MAKASI



ÜRÜN KODU	mm	g	FİYAT
P128-19-BULK30 293859	6 190 85	1	29 EUR

- Üzüm hasadı, elma ağacında daha iyi bir büyümeyi sağlamak amacıyla elmaların seyrekleştirilmesi için tavsiye edilir.
- P128-19 kutu veya karton kutuda, P128-19-BULK30 hafif plastik pakette

## P129 HASAT MAKASI



ÜRÜN KODU	mm	g	FİYAT
P129-19-BULK30 293860	6 190 85	1	24 EUR

- Meyvelerin gövdelerinden kesilmesi ve meyve dallarının temizlenmesi için
- Uzun ve ince bıçaklar, kavis (11°) taç içinde gizlenmiş salkım saplarına erişimi kolaylaştırır.





## P114-SL ÇİFT KOLLU MAKAS



ÜRÜN KODU	mm	g	FİYAT
-----------	----	---	-------

P114-SL-40	293961	30 400 630	2 102 EUR
P114-SL-50	293962	30 500 682	2 108 EUR
P114-SL-60	293963	30 600 826	2 114 EUR

- Meyve bahçelerinde ve bağlarda yumuşak ve yeşil ağaçların hasadı için.
- Dar kesme başı, hızlı ve kolay kesim için uygundur.
- Yüksek performans için profesyonel bıçak malzemesinden üretilmiştir.
- Kolay bakım için hafif alüminyum boru kollar.

## P116-SL ÇİFT KOLLU MAKAS



ÜRÜN KODU	mm	g	FİYAT
-----------	----	---	-------

P116-SL-40	293964	35 400 687	2 115 EUR
P116-SL-50	293965	35 500 735	2 119 EUR
P116-SL-60	293966	35 600 879	2 124 EUR
P116-SL-70	293967	35 700 964	2 130 EUR

- Bağ, meyve bahçeleri yada peyzaj uygulamaları için tasarlanmıştır.
- Sert ağaç kesimlerinde kolay ve profesyonel kesim için, eğimli bıçak.

## P160-SL ÇİFT KOLLU MAKAS



ÜRÜN KODU	mm	g	FİYAT
-----------	----	---	-------

P160-SL-60	293968	45 600 960	2 128 EUR
P160-SL-75	293969	45 750 1090	1 138 EUR
P160-SL-90	293970	45 900 1160	1 165 EUR

- Meyve bahçeleri ve peyzaj için özel tasarım çift kollu makas.
- İnce, dar bıçak ve kancalı ters bıçakla kuvvetli, hassas ve kolay kesim.
- Dövme bıçak, hassas ve yoğun kullanımların getirdiği zorluklar için idealdir.

## P19 ÇİFT KOLLU MAKAS

223,00 EUR



ÜRÜN KODU	mm	g	FİYAT
-----------	----	---	-------

P19-80-F	293971	50 800 1790	1
----------	--------	-------------	---

- Yaşlı ve olgunlaşmış ağaçların ve asmaların kalın ve güçlü dallarını kesmek için uygundur.
- Ayrıca uzaktan erişme, tepe kesimi için uygundur.
- Kuvvet ve temiz bir sonuç isteyen kesimler için sertleştirilmiş bıçak.
- Kolay kullanım için alüminyum kollar.

## P280-SL ÇİFT KOLLU MAKAS

111,00 EUR



ÜRÜN KODU	mm	g	FİYAT
-----------	----	---	-------

P280-SL-80	293972	55 800 1318	2
------------	--------	-------------	---

- Ağır işler için manivelalı bypass çift kollu makas.
- Daha az sürtünme için Xylan® kaplamalı, tamamen sertleştirilmiş çelik bıçaklar.
- Kuvveti %50 arttıran manivela mekanizması ile 55 mm'ye kadar kalın dalların kesim imkanı.
- Yüksek yerlere daha kolay erişmek için hafif alüminyum kollar.



## P173-SL ÇİFT KOLLU MAKAS

163,00 EUR



ÜRÜN KODU 45 850 1265 1

- Kolay erişim ve baş hizası üstünde kesim için hafif, güçlü ve uzun alüminyum tutamaklar.
- Örs ömrünün arttırmak için ayar mandalı.
- Levye mekanizma büyük kalın dalların zahmetsiz kesimi için %50 daha fazla güç sağlar.
- Yedek parçaları mevcuttur.

## PG-18 ÇİFT KOLLU MAKAS



ÜRÜN KODU 40 450 545 2 78 EUR

- Alüminyum kollar hafif çift kollu makas.
- Ağaç, çalı ve fundalık budaması için uygundur.
- Rahat kullanım için çift malzemeli kollar ve şok emici tamponlar.
- Yüksek kesme performansı için sertleştirilmiş çelik bıçaklar.

## PG-19 ÇİFT KOLLU MAKAS

88,00 EUR



ÜRÜN KODU 40 700-900 1135 1

- 70 cm'den 90 cm'e uzatabilen, alüminyum kolları profesyonel teleskopik çift kollu makas.
- Uzun ağaçlar ve kalın dalları budama için uygundur.
- Kesici ağızlar yüksek kalite sertleştirilmiş çelikten imal edilmiştir.
- Kolay kilitleme mekanizması.

## P16 ÇİFT KOLLU MAKAS



ÜRÜN KODU 30 500 935 2 104 EUR

- Meyve ağaçları ve bağcılıkta şekillendirme ve budama işlemleri için bypass makas.
- Güçlü ve hızlı kesimler için son derece kıvrımlı bıçak.
- Yedek parça mevcuttur.

## P130-P140 ÇİFT KOLLU MAKAS



ÜRÜN KODU 40 450 680 6 56 EUR

- Bahçenizde ağaç ve çalıları budama için bypass tipi çift kollu makas.
- Meyvecilik, peyzaj için daha uzun versiyonu (70cm) mevcuttur.
- Yedek parça mevcuttur.



## P34-37 TEPE DAL KESME MAKASI

103,00 EUR



ÜRÜN KODU

P34-37 294083 40 1260 2

- Tamamen sertleştirilmiş karşı bıçak ve kesici bıçak. Bıçağın yapışmaması için oluk. Daha az efor için üçlü manivela hareketi.
- Yedek parça mevcuttur.
- Ayarlı tutucu çapı 25-35 mm'e arasındaki sııklara takılabilir.

## P34-27A TEPE DAL KESME MAKASI

54,00 EUR



ÜRÜN KODU

P34-27A-F 294084 30 610 2

- 5m'lik ip ile beraber teslim edilir.
- 25 mm çapındaki sııklara takılır.
- Çift manivela sistemi. Çelik kıskaç, vidalarla gerilebilir.
- Preslenmiş, tamamen sertleştirilmiş karşı bıçak ve yapışmayı önleyici

## P134 TEPE DAL KESME MAKASI

69,00 EUR



ÜRÜN KODU

P134-BULK 294085 30 645 2

- Titiz ve etkin kesim için dilimleme hareketli tamamen sertleştirilmiş teflonlu kesici çelik bıçak. Preslenmiş ve tamamen sertleştirilmiş ters ağız.
- Ø 25 mm (1") uzatma çubuklarına uyumlu. 5m'lik ip ile birlikte teslim. Uzatma çubuğunu sabit tutan sert plastik giriş ağızı.
- Bıçağın yapışmaması için oluk. Çift manivela sistemi ile daha kolay kesim

## AP-3M TELESKOPIK UZATMA ÇUBUĞU

87,00 EUR



ÜRÜN KODU

AP-3M 294086 3500 1000 1

## PROF-H BUDAMA MAKAS KILIFI

30,00 EUR



ÜRÜN KODU

PROF-H 291688 86 2

- Budama makasları için tabii renkli dayanıklı deri kılıf. İki kemer geçme iliği, eni 50 mm'yi aşmayan kemerler. En iyi kalite deri,

## SHARP-X KARBÜR UÇLU BİLEYİCİ



ÜRÜN KODU

SHARP-X 295486 100 25 1 19,4 EUR  
SHARP-X-DISP 295487 100 25 30 612 EUR

- Her tür bıçağı bilmek için Profesyonel Tungsten-Carbide bileyici.
- Güvenli kullanımı sağlayan her iki tarafında bulunan ve parmakların bıçak kesici kenarına kaymasını önleyen koruyucu kenarlara sahiptir.
- Kolay kullanımlı ve uzun ömürlü çift taraflı karbür uç.



## 339/340 BUDAMA TESTERESİ



ÜRÜN KODU	mm	mm	g	FİYAT
339-6T	294390	360	6 250	4 37 EUR
340-6T	294391	360	6 250	4 37 EUR

- Plastik tutamaklı budama testeresi. Kendi tutamağı ile veya 25 mm'lik uzatma sırtıyla kullanılabilir. 339 sert dişlidir (Hard-Point). 340-6T modeli eğelenebilir.
- Yedek bıçakları mevcuttur.

## 4211/4212 BUDAMA TESTERESİ



ÜRÜN KODU	mm	mm	g	FİYAT
4211-11-6T	294392	280	6 225	4 37 EUR
4211-14-6T	294393	360	6 280	4 41 EUR
4212-11-6T	294394	280	6 225	4 36 EUR
4212-14-6T	294395	360	6 280	4 39 EUR

## 383/384 BUDAMA TESTERESİ



ÜRÜN KODU	mm	mm	g	FİYAT
383-6T	294396	360	6 320	4 40 EUR
384-6T	294397	360	6 320	4 38 EUR
384-5T	294398	360	5 320	4 39 EUR

- Çelik boru saplıdır. 25 mm'lik uzatma sırtında kullanmak içindir.
- 383 sertleştirilmiş uçludur. 384 eğelenebilir formdadır

## 385/386 BUDAMA TESTERESİ



ÜRÜN KODU	mm	mm	g	FİYAT
385-6T	294399	360	6 410	4 46 EUR
386-6T	294311	360	6 410	4 49 EUR

- Çelik boru saplıdır. 25 mm'lik uzatma sırtıyla kullanmak içindir.
- 386 sert dişlidir (Hard-Point). 385 eğelenebilir.

## 51-JS BUDAMA TESTERESİ



ÜRÜN KODU	mm	mm	g	FİYAT
5124-JS-H	294312	240	5 280	4 62 EUR
5128-JS-H	294313	280	5 300	4 70 EUR

- JS dişler, canlı yeşil ağaç ve dal budaması ve özellikle peyzaj için geliştirilmiştir. Rahat, yormaz, çift malzemeli tutamak.
- 2 farklı uzunlukta, her ikisi de kılıflı. Yedek bıçak mevcuttur.

## 396-JS KATLANABİLİR BUDAMA TESTERESİ



ÜRÜN KODU	mm	mm	g	FİYAT
396-JS	294314	190	5 200	4 47 EUR

- Katlanabilir budama testeresi, JS dişlidir. Özellikle meyve yetiştiriciliği, bağcılık ve peyzaj için uygundur. Kalın yeşil dalları daha hızlı kesebilmek için ekstra aralıklı diş boşluğu ve sertleştirilmiş dişler içermektedir.
- Güvenlik kilidi hem açma hem kapama için kullanılır.
- Yedek bıçağı mevcuttur.



## 41-JT BUDAMA TESTERESİ



**ÜRÜN KODU** mm g / FİYAT

4124-JT-H	294315	240	7	340	4	52 EUR
4128-JT-H	294316	280	7	356	4	58 EUR

- Bağıcılık ve meyve yetiştiriciliği için tasarlanmış kılıç testere. JT bıçak.
- Yedek bıçaklar mevcuttur.

## 396-JT KATLANABİLİR BUDAMA TESTERESİ

47,00 EUR



**ÜRÜN KODU** mm g / FİYAT

396-JT	294317	190	7	200	4	
--------	--------	-----	---	-----	---	--

- Profesyonel meyve yetiştiricileri için budama testeresi.
- Yedek bıçaklar mevcuttur.

## 396-HP KATLANABİLİR BUDAMA TESTERESİ

42,00 EUR



**ÜRÜN KODU** mm g / FİYAT

396-HP	294318	190	7	200	4	
--------	--------	-----	---	-----	---	--

- Katlanabilir budama testeresi, sert ve kuru dallar için hızlı kesim sağlayan patentli XT7 diş yapısına sahiptir. Aynı zamanda canlı ağaç, dal kesiminde de oldukça iyi sonuç verir. Güvenlik kilidi açma kapamayı kolaylaştırır.
- Yedek bıçağı mevcuttur.

## ASP-AS-C BUDAMA TESTERESİ



**ÜRÜN KODU** mm g / FİYAT

ASP-AS-C33-JT-F	294319	330	7	286	5	114 EUR
ASP-AS-C36-JT-M	294320	360	6,2	283	5	118 EUR
ASP-AS-C39-JT-C	294321	390	5,4	302	5	128 EUR
ASP-AS-C45-JT-C	294322	450	5,4	327	2	134 EUR

## KOLASTAR YEDEK BIÇAĞI - YEŞİL DAL İÇİN - ÇATAL DIŞ



**ÜRÜN KODU** mm g / FİYAT

SE-23-24	291725	607	60	10	2,2 EUR
SE-23-30	291726	759	75	10	2,4 EUR
23-15	291723	378	33	10	5,1 EUR
23-21	291724	530	45	10	9,3 EUR
23-32	291727	810	85	10	12,1 EUR
23-36	291728	912	95	10	13,2 EUR

## KOLASTAR YEDEK BIÇAĞI - YEŞİL DAL İÇİN - DÜZ DIŞ



**ÜRÜN KODU** mm g / FİYAT

SE-51-24	291731	607	65	10	2,2 EUR
SE-51-30	291732	759	80	10	2,4 EUR
51-12	291729	320	30	10	7,8 EUR
51-21	291730	530	50	10	9,3 EUR
51-32	291733	810	90	10	12,2 EUR
51-36	291734	912	100	10	12,5 EUR



## AP-234 TEPE MAKASI

141,00 EUR



ÜRÜN KODU



mm



g



AP-234-F	294070	30	2200	1520	2
----------	--------	----	------	------	---

- Budama ve temizleme fonksiyonlu tepe budama makası.
- Doğrama hareketiyle titiz ve etkin kesmeye uygun tamamen sert çelik bıçak.
- Dallara ulaşımın zor olduğu durumlar için uzun alüminyum sap.
- Rahatlığın artırılması için alüminyum kollarda kavrama yeri.

## ASP-1850 ALÜMİNYUM UZATMA ÇUBUĞU

70,00 EUR



ÜRÜN KODU



mm



g



ASP-1850	294071	1870	718	1
----------	--------	------	-----	---

- Alüminyum uzatma çubuğu çok hafif ve dengeli.
- 3,70m (1 ilave çubuk - maksimum çalışma aralığı 5,20m) veya 5,57m (2 ekstra çubuk - maksimum çalışma mesafesi 7,07m).
- Hızlı aparat takma sistemi.

## ASP-1850G ALÜMİNYUM UZATMA ÇUBUĞU

83,00 EUR



ÜRÜN KODU



mm



g



ASP-1850G	294072	1870	795	1
-----------	--------	------	-----	---

- Güçlü alüminyum çubuk hafif ve dengelidir. Kaymaz kaplamalıdır.
- 3,70m (ekstra 1 çubuk - maksimum erişilebilir 5,20m) veya 5,57 m (2 ekstra çubuk - maksimum çalışma mesafesi 7,07 m).
- Sırk testereleri veya tepe budama aletlerini kontrol etmek için patentli hızlı takma sistemine sahiptir.

## ASP3740 TESTERELİ UZATMA SETİ



ÜRÜN KODU



mm



g



FİYAT

ASP3740-C36JTM	294073	360	3740	2819	1	345 EUR
ASP3740-C45JTC	294074	450	3740	2863	1	370 EUR

- Bir taban direği ASP-1850G, bir uzatma çubuğu ASP-1850, 360mm veya 450 mm bıçaklı testereden oluşan yüksekte budama seti.
- Kolay taşınması ve depolanması için konforlu kumaş torbasında.

## ASP3740-P TEPE BUDAMA SETİ

405,00 EUR



ÜRÜN KODU



mm



g



ASP3740-P3437	294075	40	3740	3878	1
---------------	--------	----	------	------	---

- Bir uzatma çubuğu ASP-1850G, bir uzatma çubuğu ASP-1850, bir tepe dal budama makası P34-37 be bir tepe dal budama makası adaptörü ASP-ATP içeren yüksek dal budama seti.
- Kolay taşıma ve depolama için dayanıklı bir polyester çanta tedarik edilir.



## P51-SL ÇİT MAKASI

111,00 EUR



ÜRÜN KODU	mm	g	
P51-SL 294535	250 570	990	1

- Özellikle peyzaj, bahçe ve park tasarımları için profesyonel yüksek kalite makaslar. Tamamen sertleştirilmiş bıçaklar.
- Kısmi çentikli bıçak sayesinde 10mm ye kadar kalın dalları kesme özelliği
- Plastik tutma yerleri ve hafif alüminyum kollar.

## P51H-SL ÇİT MAKASI

119,00 EUR



ÜRÜN KODU	mm	g	
P51H-SL 294536	250 730	1076	2

- Peyzaj, parklar, bahçe süslemeleri için yüksek kalite sertleştirilmiş bıçağı.
- Kısmi çentikli bıçak ile 10mm ye kadar olan kalın dalları kes.
- Daha iyi erişim için ekstra uzun, hafif alüminyum kollar.
- Rahat tutuş ve üstün kesme performansı sayesinde yorgunluğu azaltır.

## P54-SL ÇİT MAKASI



ÜRÜN KODU	mm	g		FİYAT
P54-SL-20 294537	180 500	742	2	149 EUR
P54-SL-25 294538	225 550	813	2	134 EUR

- Park, fidanlık ve bağlar için kısa kollu yüksek kalite makaslar.
- Kompakt tasarım ve açılı form, süs bahçeciliği ve yaprak budama işlemleri için.

## P54H-SL ÇİT MAKASI



ÜRÜN KODU	mm	g		FİYAT
P54H-SL-20 294539	180 600	787	2	135 EUR
P54H-SL-25 294540	225 650	871	2	121 EUR

- Park, fidanlık ve bağcılık için profesyonel yüksek kalite uzun kollu makas.
- Kompakt tasarım ve açılı form, bahçe süslemeciliği ve yaprak budama işlemleri için.

## PG-56 ÇİT MAKASI

100,00 EUR



ÜRÜN KODU	mm	g	
PG-56-F 294541	230 540	850	2

- Tüm çit, çalılık budanması için hafif makas.
- Tamamen sertleştirilmiş çelik bıçaklar.
- Çift malzemeli alüminyum kollar.
- Darbe emici tampon ile kullanım rahatlığı.

## PG-57 TELESKOPIK ÇİT MAKASI

107,00 EUR



ÜRÜN KODU	mm	g	
PG-57-F 294542	200 800-1050	1345	2

- 80 cm den 105 cm'e kadar uzayabilen çok hafif teleskopik çit makası.
- Özel kilitleme mekanizması. Çeyrek dönüşle açma/kapama.
- Tamamen sertleştirilmiş çelik bıçaklar.
- Alüminyum kollar ve çift malzemeli kavrama yeri.
- Rahat kullanımı artırıcı kauçuk darbe emici tampon.

## P51 ÇİT MAKASI

100,00 EUR



ÜRÜN KODU	mm	g	FIYAT
P51-F	250	570	1085

- Parklarda, üzüm bağlarında ve özellikle sanatsal düzenleme çalışmalarında profesyonel amaçlı kullanım için tamamen sertleştirilmiş bıçaklar.
- 10mm /ye kadar kalın dalların kesimi için kısmi çentikli bıçaklar.
- Yedek parça mevcuttur.

## P57-25 ÇİT MAKASI



ÜRÜN KODU	mm	g	FIYAT
P57-25-F	230	540	1020
P57-25W-F	230	540	1020

- Preslenmiş ve tamamen sertleştirilmiş bıçak düz bıçağı ve kıs ağızıyla 10 mm. ye kadar dalları kesmek için.
- Yedek parça mevcuttur.

## P59-25-F ÇİT MAKASI

66,00 EUR



ÜRÜN KODU	mm	g	FIYAT
P59-25-F	210	580	1030

- Bahçe çalılıklarının budanmasında sık kullanım için uygundur.
- Bağcılıkta yaprak budama ve peyzaj çalışmaları için uygundur.
- Yedek parça mevcuttur.

## GS-76 ÜÇ AÇILI ÇİM KESME MAKASI

28,00 EUR



ÜRÜN KODU	mm	g	FIYAT
GS-76	355	435	6

- Bıçak açıları kullanım sırasında kendi kendini bileyecek şekildedir.
- Bıçaklar değişik uygulamalar için üç farklı açığa ayarlanabilir.
- Bıçaklar sadece çim kesmek için kullanılır bu nedenle serttir.
- Yedek parça mevcut değildir.

## P74 ÇİM MAKASI

62,00 EUR



ÜRÜN KODU	mm	g	FIYAT
P74	1100	2000	1

- Çim kesme makinalarının giremediği, ulaşılması zor yerlerde kesim yapmak için kullanılır. Çalılıklar, sınırlar, ağaçların çevreleri vs. gibi kesimler için uygundur. Yatay duran bıçaklarıyla ördek ayağı olarak da bilinir. 90cm uzunluktaki yuvarlak kollar, siyah plastik kaplamalıdır.

## P75 ÇİM MAKASI

60,00 EUR



ÜRÜN KODU	mm	g	FIYAT
P75	1000	1900	1

- Sınırların ve çim biçme makinasının giremediği alanlarda kullanılır.Çim kenarları düzenlemek için ideal seçim.
- 90cm uzunluktaki yuvarlak çelik borudan kollar, siyah plastik kaplamalıdır.
- Titreşimi önleyici plastik tamponlar.



## 396-LAP / 396-BLADE (YEDEK BIÇAK)



ÜRÜN KODU	mm	g	FİYAT			
396-LAP	294351	190	405	200	10	42 EUR
396-BLADE	291752	190	-	44	10	18,1 EUR

• Hem yeşil, hem kuru ağaç, plastik, kemik vb. kesmek için genel amaçlı katlanabilir testere. Avcılar ve kampçılar için özel olarak tasarlanmıştır.

• Düşük sürtünme için ve paslanmaya karşı özel kaplama.

## 2444-LAP LAPLANDER BIÇAK

25,00 EUR



ÜRÜN KODU	mm	g	FİYAT			
2444-LAP	294253	100	220	100	10	

• Çok amaçlı kullanım için sağlam bir paslanmaz çelik bıçak.

• Ürünün uzunluğu 220 mm, bıçak uzunluğu 102 mm.

• LAPLANDER logolu kemer taşıma için pratik bir kılıf ile birlikte.

## LAP-KNIFE KATLANIR TESTERE VE BIÇAK SETİ

66,00 EUR



ÜRÜN KODU	g	FİYAT		
LAP-KNIFE	294354	329	10	

• 396-LAP testere ve 2444-LAP bıçaktan oluşan set.

• Bıçak hem paslanmaya karşı hem de az sürtünme için özel kaplanmıştır.

• Mükemmel kavrama için iki malzemeli plastik sap. Deri ince halat. Güvenlik kilidi hem açık hem de kapalı iken aktiftir.

## 2446 TÜCCAR BIÇAĞI

17,60 EUR



ÜRÜN KODU	mm	g	FİYAT			
2446	294256	100	225	120	15	

• Çok amaçlı kullanım için sağlam bir paslanmaz çelik bıçak.

• Kullanımda rahatlık ve güvenli bir tutuş için çift malzeme sap.

• Belde taşıma için pratik kılıflı.

• 15 li teşhir panosu mevcuttur.

## SB-2449 YARMA BIÇAĞI

37,00 EUR



ÜRÜN KODU	mm	g	FİYAT			
SB-2449	294250	103	235	193	12	





## 2446-LINO BIÇAĞI

13,00 EUR



ÜRÜN KODU



mm

g



2446-LINO	294258	55	180	110	12
-----------	--------	----	-----	-----	----

- Olağanüstü bileme.
- Halı kesiminde kullanılan özel tasarım.
- Lino Bıçağı.

## KBSK-01 SPOR BIÇAK

26,00 EUR



ÜRÜN KODU



mm

g



KBSK-01	294259	70	170	110	5
---------	--------	----	-----	-----	---

- 70mm / 3" bıçak.
- Emniyet kilitli.
- İp kesmek için özel kısım.

## K-AP-1 BUDAMA BIÇAĞI

41,00 EUR



ÜRÜN KODU



mm

g



K-AP-1	294260	75	175	90	10
--------	--------	----	-----	----	----

- Bütün bahçecilik işlerinde, budama, çiçek, ip, plastik, kağıt gibi malzeme lerin kesimi için budama bıçağı.
- Cebe sığması için yassı dizayn edilmiştir.
- Paslanmaz çelikten, yay şeklinde katlanabilir bıçak.

## K-GP-1 BUDAMA BIÇAĞI

44,00 EUR



ÜRÜN KODU



mm

g



K-GP-1	294261	70	170	90	10
--------	--------	----	-----	----	----

- Bütün bahçecilik işlerinde, budama, çiçek, ip, plastik ve benzeri malzemelerin kesimi için budama bıçağı.
- Cebe sığması için yassı dizayn edilmiştir.
- Paslanmaz çelikten, yay şeklinde katlanabilir bıçak.

## P20 BUDAMA BIÇAĞI

57,00 EUR



ÜRÜN KODU

mm

g



P20	294162	190	100	6
-----	--------	-----	-----	---

- Şeftali gibi çok narin ağaçların budanması için uygundur.
- Aynı zamanda genç ağaç ve fidanların budanması yada meyve salkım larının islahi için de uygundur.
- Özel olarak kanca şeklinde tasarlanmış katlanabilir bıçak.

## P11 AŞI BIÇAĞI

48,00 EUR



ÜRÜN KODU

mm

g



P11	294163	180	70	16
-----	--------	-----	----	----

- Yüksek kalite aşı bıçağı, aşı ve ağaç kabuğunun jilet keskinliğinde kesil-mesi ve kabuğun aşıyı sokmak amacıyla kaldırılması içindir.
- Aşılama yapılacak ağaç kabuğunu kaldırmak için yuvarlak köşeli spatula.
- Son derece keskin katlanabilir bıçak, katlanabilir prinç spatula ve rahat tutuş için plastik gövde.

## FGS DEVİRME BALTASI



ÜRÜN KODU	mm	g	FİYAT
FGS-1.0-600 294864	600	1330	4 58 EUR
FGS-1.25-700 294865	700	1850	4 54 EUR

- Ufak ağaçların kesimi için. Temiz ve kolay kesimler sağlar.
- Kıvrık dişbudak tutamak, oluklu karbon fiber kamayla sabitlenmiş.
- Yüksek kalite sertleştirilmiş takım çeliği, DIN 17200, carbon 45'e uygun.

## FGS-810 DEVİRME BALTASI



ÜRÜN KODU	mm	g	FİYAT
FGS-1.6-810 294866	800	2230	4 68 EUR
FGS-1.8-810 294867	800	2480	4 75 EUR

- Ağaç kesimleri ve budama için kullanılır.
- İnce, geniş bıçağı dalda temiz ve kolay bir kesim sağlar.
- Yüksek kaliteli sertleştirilmiş takım çeliği, DIN 17200, carbon 45'e uygun.

## FCP DEVİRME BALTASI



ÜRÜN KODU	mm	g	FİYAT
FCP-1.6-810 294868	800	2540	4 77 EUR
FCP-2.3-860 294869	850	3000	2 113 EUR

- Ağaç kesmek ve kesilmiş ağaçların dallarını temizlemek için ideal seçim.
- Yüksek kaliteli sertleştirilmiş takım çeliği, DIN 7287, class B'ye uygun.
- Birinci sınıf amerikan ceviz ağacı tutamak.

## HUS-1.0 KAMP BALTASI

48,00 EUR



ÜRÜN KODU	mm	g	FİYAT
HUS-1.0-650 294870	650	1610	4

- Bahçe işleri, arasıra yapılan dal şekillendirmesi ve yarılmaları gibi genel amaçlı uygulamalar için. Yüksek kalite sertleştirilmiş çeliği, DIN 7287, class B'ye uygun. Kıvrık dişbudak sap, DIN 5132, class B'ye uygun, oluklu karbon fiber kamayla sabitlenmiştir.

## HUS KAMP BALTASI



ÜRÜN KODU	mm	g	FİYAT
HUS-0.6-380 294871	380	830	4 43 EUR
HUS-0.8-500 294872	500	1030	4 48 EUR

- Kampçılık, bahçe işleri ve dal şekillendirmesi gibi genel amaçlı uygulamalar için. Yüksek kaliteli sertleştirilmiş takım çeliği, DIN 7287, class B'ye uygun.

## HGPS KAMP BALTASI



ÜRÜN KODU	mm	g	FİYAT
HGPS-0.6-360 294873	360	810	4 23 EUR
HGPS-0.8-380 294874	380	930	4 37 EUR
HGPS-1.0-400 294875	400	1180	4 36 EUR

- Hobi amaçlı, her yerde kullanılabilir genel amaçlı balta.
- İnce tasarım temiz kesimler sağlar.

## HFGPS GENEL AMAÇLI BALTA

50,00 EUR



ÜRÜN KODU

mm

g



HFGPS-0.7-400FG

294876

380

1010

4

- Genel amaçlı kısa balta, hafif uygulamalarda kullanılır.

- Baltanın arka kısmı çekiç vazifesi görebilir.

- Üç bileşenli tutamak (elastomer ve fiberglas ile polipropilen güvenlik ve uzun ömür sağlar).

## SUC KOMPOZİT TUTAMAKLI AYIRMA BALTASI



ÜRÜN KODU

mm

g



FİYAT

SUC-0.9-600

294878

600

1310

4

75 EUR

SUC-1.7-800

294880

780

2300

4

105 EUR

## CUC KOMPOZİT TUTAMAKLI KAMP BALTASI

45,00 EUR



ÜRÜN KODU

mm

g



CUC-0.4-360

294881

360

640

4

- Karbon çeliğinden dövülmüş kafa. Tamamen sertleştirilmiş ve temperlenmiş 51 HRC. Bilenmiş bıçak ağız. Ağacı doğramak için dar yanaklar. Tekrar kullanılabilir bir baş koruyucuyla birlikte.

- Cam elyaf takviyeli kompozit malzemeden tutamak.

## FFSS DEVİRME BALTASI

64,00 EUR



ÜRÜN KODU

mm

g



FFSS-1.5-900FG

294883

900

2400

4

- Uzun ve düz tutamağı, uzun bir salınım ve derin bir kesim sağlar.

- Üç bileşenli tutamak (fiberglas, polipropilen ve elastomer) konfor, güvenlik ve uzun ömür sağlar. Non-slip tutamak yumuşak ve güvenli kavrama sağlar ve büyük süspansiyon delikleri baltayı duvara asmayı kolaylaştırır.

## LS/MES AYIRMA BALTASI



ÜRÜN KODU

mm

g



FİYAT

LS-MERLIN-2.5

294884

900

3270

2

61 EUR

LS-MERLIN-2.5FG

294885

900

3330

2

75 EUR

MES-3.0-900

294886

900

3620

2

77 EUR

- Hem yarma baltası olarak hemde balyoz olarak kullanılır.

- LS-MERLIN-2.5FG modeli üç bileşenli fiberglas tutamağı.





## SUS AYIRMA BALTASI

117,00 EUR



ÜRÜN KODU	mm	g	
SUS-2.0-800	294887	800	2660

- Yarma sırasında, daha iyi girmek için ağır bir balta.
- Kıvrık dişbudak tutamak, oluklu karbon fiber kamayla sabitlenmiş.
- Baş, karbonfiber ile güçlendirilmiş ve ilave olarak metal yüzüklü takoz.

## MCP AYIRMA BALTASI

103,00 EUR



ÜRÜN KODU	mm	g	
MCP-2.5-810	294888	800	3300

- Ağır bir yarma baltasıdır, hem yarma baltası olarak hem de kamaları çakmak için balyoz olarak kullanılır. Zor ve çok kalın ağaç kesimi için amaçlanmıştır.
- Birinci sınıf ceviz ağacı tutamak.

## MES YARMA BALTASI



ÜRÜN KODU	mm	g		FİYAT	
MES-3.5-900	294889	900	3880	2	84 EUR
MES-3.5-900FG	294890	900	4310	2	91 EUR

- Hem yarma baltası olarak hemde balyoz olarak kullanılır.
- Ağaç gövdeleri için başta döner kanca.
- MES-2.5-900FG seçeneği üç bileşenli fiberglas tutamak.

## LS-MASSE BALYOZ



ÜRÜN KODU	mm	g		FİYAT	
LS-MASSE-4FG	294991	900	4800	2	68 EUR
LS-MASSE-4	294992	900	4450	2	65 EUR

- Kazık çakmak ve zor ağaç tiplerine yarma kaması çakmak için kullanılır.
- Yüksek kalite takım çeliği, her iki yanda da düz.
- LS-MASSE-4FG seçeneği üç bileşenli fiberglas tutamak.

## LS-6160-23 SENTETİK BİLEME TAŞI 220

9,70 EUR



ÜRÜN KODU	mm	g	
LS-6160-23	295493	230	170

- Kesici aletlerde iyi bilenmiş yüzeyler meydana getirir.
- Bu taş tam performans için suyla nemlendirilmelidir.

## LS-PIERRE-FAUX SENTETİK BİLEME TAŞI 180

17,80 EUR



ÜRÜN KODU	mm	g	
LS-PIERRE-FAUX	295494	230	210

- Tırpan ve balta gibi az hassas bıçakları bilemek için kullanılır.
- Bu bileme taşını kullanırken, tam verimlilik için mazot ya da yağ ile nemlendirildiğinde tam etkilidir.

## P263 KÜREK

19,20 EUR



ÜRÜN KODU	mm	g	
P263	294716	370	10 5

- Her türlü hendek oluşturmada, saksı yada toprağa dikimde ve gübre veya kuru otları dağıtma işi için.
- Paslanmaya karşı epoksi toz kaplama ve tamamen sertleştirilmiş çelik.
- Islak ve ağır toprağı kazmada dayanıklı.
- Yumuşak kavrama yeri ve rahat kullanım için polipropilen yuvarlak tutamak. Etiket çıkartıldıktan sonra askı olarak kullanılabilir.

## P268 TEK DİŞLİ ÇAPA

17,70 EUR



ÜRÜN KODU	mm	g	
P268	294717	320	10 5

- Enli ağız bıçağı, sertleşmiş toprağı kırmak ve toprağı otlardan temizleyerek gevşetmek için.
- Dişli çapa ağız, dikim hattını yapmak için kullanılır.
- Paslanmaya karşı epoksi toz kaplama ve tamamen sertleştirilmiş çelik.
- Yumuşak kavrama yeri ve rahat kullanım için polipropilen yuvarlak tutamak. Etiket çıkartıldıktan sonra askı olarak kullanılabilir.

## P269 YABANI OT SÖKÜCÜ

13,90 EUR



ÜRÜN KODU	mm	g	
P269	294718	315	10 10

- Özellikle karahindiba, devedikeni gibi derin köklü yabancı otların temizlenmesi ve köklerinin çıkartılmasına uygundur.
- Paslanmaya karşı epoksi toz kaplama ve tamamen sertleştirilmiş çelik.
- Yumuşak kavrama yeri ve rahat kullanım için polipropilen yuvarlak tutamak.
- Etiket çıkartıldıktan sonra askı olarak kullanılabilir.

## P270 OT YOLMA ÇATALI

16,50 EUR



ÜRÜN KODU	mm	g	
P270	294719	305	199
			10

- Dikimden önce, yerin gevşemesi, temizlenmesi ve tesviye işlemleri için.
- Bitkilerin arasındaki otların temizlenmesi ve bitkilerin yeni aynı zamanda havuç ve turp gibi kök sebzelerin toplanması için kullanılır.
- Paslanmaya karşı epoksi toz kaplama ve tamamen sertleştirilmiş çelik.
- Yumuşak kavrama yeri ve rahat kullanım için polipropilen yuvarlak tutamak.

## P272 ÇAPA

22,00 EUR



ÜRÜN KODU	mm	g	
P272	294720	450	270
			5

- Sertleşmiş, tıkanmış toprağın kırılması ve gevşemesi için kullanılır. Ekime hazırlanacak toprak için kullanılır.
- Paslanmaya karşı epoksi toz kaplama ve tamamen sertleştirilmiş çelik.
- Daha iyi bir erişim için, küçük bahçe aletlerine oranla 10cm daha uzun kol. Yumuşak kavrama yeri ve rahat kullanım için polipropilen yuvarlak tutamak.
- Etiket çıkartıldıktan sonra askı olarak kullanılabilir.

## P274 KÜLTİVATÖR

22,00 EUR



ÜRÜN KODU	mm	g	
P274	294721	470	230
			5

- Kullanım alanı, toprağı gevşetmek ve havalandırmak için.
- Yabani otları kontrol ederek, fidanların büyümelerine destek olur.
- Paslanmaya karşı epoksi toz kaplama ve tamamen sertleştirilmiş çelik. • Daha iyi bir erişim için, küçük bahçe aletlerine oranla 10cm daha uzun kol.
- Yumuşak kavrama yeri ve rahat kullanım için polipropilen yuvarlak tutamak. Etiket çıkartıldıktan sonra askı olarak kullanılabilir.

## P276 TIRMİK

22,00 EUR



ÜRÜN KODU	mm	g	
P276	294722	450	230
			5

- Temizleme, tesviye ve bitkilerin arasındaki toprağı düzeltme için küçük tirmik. Tohumları örtmek veta yerdeki kuru ot yığını dağıtmak için de kullanılır.
- Paslanmaya karşı epoksi toz kaplama ve tamamen sertleştirilmiş çelik.
- Daha iyi bir erişim için, küçük bahçe aletlerine oranla 10cm daha uzun gövde. Yumuşak kavrama yeri ve rahat kullanım için polipropilen yuvarlak tutamak.



## P277 İKİ DİŞLİ ÇAPA

22,00 EUR



ÜRÜN KODU	mm	Ø	g	FIYAT
P277	294723	455	260	5

- Çeşitli işler için gübreleme çapası.
- Birinci baş, sertleşmiş toprağı kırıp gevşetmek yada otların kesimi için.
- İki dişli çatal baş toprağı gevşetip havalandırmak için.
- Yumuşak kavrama yeri ve rahat kullanım için polipropilen yuvarlak tutamak. Etiket çıkartıldıktan sonra askı olarak kullanılabilir.

## P278 ÇAPA

22,00 EUR



ÜRÜN KODU	mm	Ø	g	FIYAT
P278	294724	455	230	5

- Toprağı hazırlamak için çapa. Ekim ve dikimde hazırlanacak hat için kullanılır.
- Tıkanmış, sertleşmiş toprağı kırmak ve toprağı otlardan temizleyerek gevşetmek için enli ağız. Paslanmaya karşı epoksi toz kaplama ve tamamen sertleştirilmiş çelik.
- Daha iyi bir erişim için, küçük bahçe aletlerine oranla 10cm daha uzun kol.

## P241 FİDE DİKİCİ

13,20 EUR



ÜRÜN KODU	mm	Ø	g	FIYAT
P241	294725	340	340	5

- Toz boya kaplamalı ve yapışmaz yüzeyli soğan dikici.
- Sert ahşap tutamak.
- Her tür soğanı ve küçük bitkiyi dikmek içindir.

## 168-1P YUVARLAK ZİNCİR TESTERE EĞESİ



ÜRÜN KODU	mm	Ø	g	FIYAT		
168-6-3.2-1P	295026	150	3,2	13	12	2,10 EUR
168-6-3.5-1P	295027	150	3,5	15	12	2,10 EUR
168-8-4.0-1P	295028	200	4,0	23	12	2,10 EUR
168-8-4.5-1P	295029	200	4,5	27	12	2,10 EUR
168-8-4.8-1P	295030	200	4,8	31	12	2,10 EUR
168-8-5.2-1P	295031	200	5,2	36	12	2,10 EUR
168-8-5.5-1P	295032	200	5,5	39	12	2,10 EUR
168-8-6.3-1P	295033	200	6,3	51	12	2,10 EUR

- Yuvarlak zincir testere egesi, zincir testeredeki kesici dişlerin bilenmesi içindir.
- Her ege koruyucu kılıf olarak tekrar kullanılabilir bir ambalaja sahiptir.

## 4-187-0 ÜÇGEN EXTRA İNCE TESTERE EĞESİ

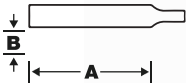

ÜRÜN KODU	A mm	B mm	g	FIYAT		
4-187-04-2-0	295265	100	5	12	10	4,90 EUR
4-187-45-2-0	295266	112	6	20	10	6,40 EUR
4-187-05-2-0	295267	125	6	23	10	6,40 EUR
4-187-06-2-0	295268	150	7	27	10	5,60 EUR
4-187-07-2-0	295269	175	8,5	47	10	9,70 EUR

- Universal ince dişli tüm testere kılıflarının bilenmesinde kullanılır.
- Yüzeyler ve köşeler tekli kesim.
- Diş formu: 2 = Orta

## 168-3P YUVARLAK ZİNCİR EĞESİ



ÜRÜN KODU	mm	Ø	g		FİYAT
168-6-3.2-3P 295034	150	3,2	13	12	5,10 EUR
168-6-3.5-3P 295035	150	3,5	15	12	5,10 EUR
168-8-4.0-3P 295036	200	4,0	23	12	5,10 EUR
168-8-4.5-3P 295037	200	4,5	27	12	5,10 EUR
168-8-4.8-3P 295038	200	4,8	31	12	5,10 EUR
168-8-5.2-3P 295039	200	5,2	36	12	5,10 EUR
168-8-5.5-3P 295040	200	5,5	39	12	5,10 EUR
168-8-6.3-3P 295041	200	6,3	51	12	5,10 EUR

• Yuvarlak zincir testere egesi, zincir testeredeki kesici dişlerin bilenmesi içindir.

• Eğeler birbirinden kolayca ayrılan koruyucu kılıflarla üçlü olarak paketlenmiştir.

• Bir kutusunda 12 tane üçlü paket bulunur. (36 adet)

## 168-8 YUVARLAK ZİNCİR TESTERE EĞESİ, 6LI KUTU



ÜRÜN KODU	mm	Ø	g		FİYAT
168-8-4.0-6 295042	200	4,0	23	6	10,20 EUR
168-8-4.5-6 295043	200	4,5	27	6	10,20 EUR
168-8-4.8-6 295044	200	4,6	31	6	10,20 EUR
168-8-5.2-6 295045	200	5,2	36	6	10,20 EUR
168-8-5.5-6 295046	200	5,5	39	6	10,20 EUR

• Yuvarlak zincir testere egesi, zincir testeredeki kesici dişlerin bilenmesi içindir.

• Yeni 6'lı paketleme, çevreci, kolay taşınabilen ve pratiktir.

• Dış kutu teşhir ünitesi olarak da kullanılabilir.

• 10 adet 6'lı paket. (60 ege).

## 168-C ZİNCİR TESTERE EĞE SETİ



ÜRÜN KODU	mm	Ø	g		FİYAT
168-COMBI-4.0 295342	200	4,0	150	10	11,90 EUR
168-COMBI-4.5 295343	200	4,5	150	10	12,70 EUR
168-COMBI-4.8 295344	200	4,8	160	10	11,90 EUR
168-COMBI-5.5 295345	200	5,5	175	10	11,90 EUR

• Bilimsel ERGO™ prosese göre geliştirilmiş ege tutamağı.

• İki yuvarlak zincir testere egesi.

• 6" inçlik yassı egeden oluşan kombine paket.

## 168-C-G ZİNCİR TESTERE EĞE SETİ



ÜRÜN KODU	mm	Ø	g		FİYAT
168-COMBI-4.0-6922 295346	200	4	185	4	25 EUR
168-COMBI-4.8-6920 295347	200	4,8	198	4	25 EUR
168-COMBI-5.5-6924 295348	200	5,5	210	4	25 EUR

• Bilimsel ERGO™ prosese göre geliştirilmiş ege tutamağı.

• Pakette iki yuvarlak zincir testere egesi, bir 6" inçlik yassı ege vardır.

• Her iki yuvarlak ve yassı zincir testere egesiyle de en iyi sonuçları garanti etmek için bir eğeleme kılavuzu da eklenmiştir.

## 166-2 YASSI ZİNCİR TESTERE EĞESİ

8,60 EUR



ÜRÜN KODU	A mm	B mm	C mm	g	5
166-6-16-2.5-2 295349	150	16	2,5	105	5

- Bilimsel ERGO™ prosese göre geliştirilmiş ege tutamağı.
- Yan yüzeyleri dişsiz ve yuvarlatılmış, paralel lama ege. Zincir testere derinlik mastarı ve çalı tırpanı bıçaklarının bilenmesi için.

## 166/167-12 YASSI ZİNCİR TESTERE EĞESİ

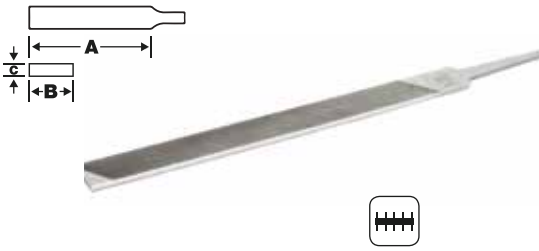

ÜRÜN KODU	A mm	B mm	C mm	g	12	FİYAT
166-6-16-2.5-12 295150	150	16	2,5	48	12	3,70 EUR
167-8-21-3.2-12 295151	200	16	3,2	94	12	6,20 EUR

- Yan yüzleri dişsiz ve yuvarlatılmış.
- Paralel lama ege, zincir testere derinlik mastarı ve çalı tırpanı bıçaklarının bilenmesi için.
- Endüstriyel pakette, tutamaksız olarak gönderilmektedir

## 4-183-0 ÜÇGEN REGULAR TESTERE EĞESİ

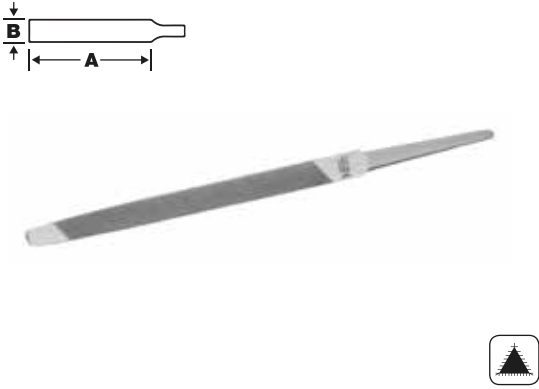

ÜRÜN KODU	A mm	B mm	g	10	FİYAT
4-183-04-2-0 295252	100	8,5	30	10	4,00 EUR
4-183-45-2-0 295253	112	10	40	10	6,50 EUR
4-183-05-2-0 295254	125	11	50	10	4,60 EUR
4-183-06-2-0 295255	150	12,5	80	10	5,50 EUR
4-183-07-2-0 295256	175	13,5	105	10	6,50 EUR
4-183-08-2-0 295257	200	15,5	160	10	8,60 EUR
4-183-10-2-0 295258	250	17,5	245	10	13,10 EUR

- Çapraz dişli ve dişleri 60° derece açılı testereleri bilemek içindir.
- Yüzeyler ve köşeler tekli kesim. Verilen kesit ölçüsü eğenin kuyruk-taki en büyük kenar genişliğidir. Endüstriyel pakette, tutamaksız.
- Diş formu: 2 = Orta.

## 4-186-0 ÜÇGEN İNCE TESTERE EĞESİ

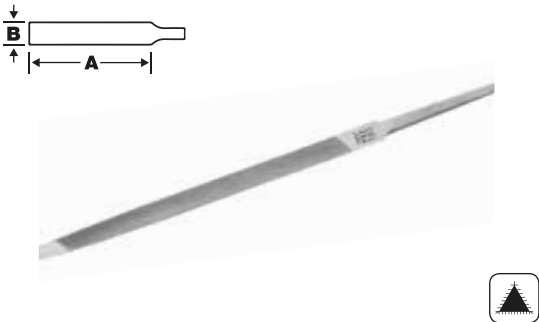

ÜRÜN KODU	A mm	B mm	g	10	FİYAT
4-186-04-2-0 295259	100	6	15	10	4,60 EUR
4-186-45-2-0 295260	112	7	20	10	4,60 EUR
4-186-05-2-0 295261	125	7	25	10	4,60 EUR
4-186-06-2-0 295262	150	8,5	40	10	4,60 EUR
4-186-07-2-0 295263	175	10	65	10	6,50 EUR
4-186-08-2-0 295264	200	12	105	10	7,30 EUR

- Çapraz ve ince dişli tüm testerelerin bilenmesinde kullanılır.
- Yüzeyler ve köşeler tekli kesim.
- Diş formu: 2 = Orta





**PULMIC.**®





# FENIX PURE SERİSİ İLE MALİYETTEN, EFORDAN VE ZAMANDAN KAZANIN!

## FENIX PURE

ÜRÜN KODU: 951801

104 EUR



## FENIX PURE HOOD

ÜRÜN KODU: 951805

118 EUR





## PEGASUS 15

ÜRÜN KODU: 951901

**246 EUR**

**15 Litre**

Yedi saate kadar dayanabilen lityum pili ve 3 kademeli deviri ile profesyonel işler için üretilmiştir.



## PEGASUS 35

ÜRÜN KODU: 951902

**310 EUR**

**35 Litre**

Pulmic Pegasus 35 Elektrikli İlaçlama Makinesi, iki tekerlekli, kolay taşımaya sağlayan katlanır saplı ve 35 litrelik tank kapasiteli olarak tasarlanmıştır.



## RAPTOR 1

ÜRÜN KODU: 951802

**2,30 EUR**

**1 Litre**

Pulmic Raptor 1, ev ve bahçe işleri için hidrolik tetikli bir püskürtücüdür. Bu sprey, Raptor ailesinin en az kapasiteli, hafif ve taşınması kolay olanıdır.



## RAPTOR 2

ÜRÜN KODU: 951803

**16,60 EUR**

**2 Litre**

Pulmic Raptor 2, taşınması kolay ve tutmayı kolaylaştıran yeni bir sapa sahip basınçlı bir spreydir. Önceki basıncın hidrolik püskürtücüsü. Böcek öldürücülerin, mantar öldürücülerin ve herbisitlerin uygulanması için kullanılır.







## RAPTOR 2000 VİTON

ÜRÜN KODU: 951806

**38 EUR**

### 1,5 Litre

1,5 Litre kapasiteli Pulmic Industrial 2000 püskürtme makinesinin Viton mafsalı sayesinde taşınması kolaydır ve çok dayanıklıdır. Üstelik yeni başlığın tasarımı, ergonomik sap sayesinde püskürtme makinesinin tutulmasını kolaylaştırıyor.



## RAPTOR 16 ADVANCE

ÜRÜN KODU: 951804

**60 EUR**

### 16 Litre

Pulmic Raptor 16 Advance, tarım kimyasallarının uygulanmasına yönelik manuel bir hidrolik püskürtme makinesidir. Bu makine Raptor ailesinin gelişmiş versiyonudur.



## RAPTOR 7

ÜRÜN KODU: 951807

**27 EUR**

### 5 Litre

Böcek öldürücülerin, mantar öldürücülerin ve herbisitlerin uygulanması için. Bu basınçlı sprej, kullanışlı sapı sayesinde omuz üzerinden veya manuel olarak taşınabilir. Tabanı tanka stabilite kazandıracak şekilde tasarlanmıştır.



## RAPTOR 7 VİTON

ÜRÜN KODU: 951808

**104 EUR**

### 5 Litre

Viton bağlantıları sayesinde güçlüdür ve hortumu inşaat, otomobil, endüstriyel makinelerin temizliği, yüzme havuzu temizliği ve dış zemin döşemelerindeki uygulamalar için mükemmel kılar.



**BİTKİ BAĞLAMA TABANCASI**

ÜRÜN KODU: 959901

**55 EUR****BİTKİ BAĞLAMA BANDI**

ÜRÜN KODU: 959902

**0,90 EUR****BİTKİ BAĞLAMA BANDI**

ÜRÜN KODU: 959903

**0,90 EUR****AHŞAP SAP**

ÜRÜN KODU: 954607

**2,30 EUR****TİTANYUM SAP**

ÜRÜN KODU: 954606

**4,80 EUR****TIRMIK(FINDIK TOPLAMA)**

ÜRÜN KODU: 954601

**5,50 EUR****TIRMIK(FINDIK TOPLAMA)**

ÜRÜN KODU: 954602

**4,90 EUR****TIRMIK(FINDIK TOPLAMA)**

ÜRÜN KODU: 954603

**3,90 EUR****TIRMIK(ZEYTİN TOPLAMA)**

ÜRÜN KODU: 954605

**1,90 EUR****TIRMIK(YAPRAK, ÇİM)**

ÜRÜN KODU: 954604

**3,30 EUR**

A photograph of a person operating a blue tractor in a field. The tractor is blue with a large black tire on the left side. The operator is wearing dark clothing and boots. The background shows a stone wall and a window. A large blue oval with the text 'SEP' is overlaid on the image.

**SEP**



## SEP 113



## SEP 125

ÜRÜN KODU: 490115

**2996 EUR**



KOD	MOTOR	GÜÇ	YAKIT	ÇALIŞTIRMA	FİYAT
490113	HONDA GX200	6,5 HP	BENZİN	İPLİ	3264 EUR
490114	KAMA KD70	6,7 HP	DİZEL	İPLİ	3478 EUR

MOTOR	GÜÇ	YAKIT	ÇALIŞTIRMA
CHANGFA CF186	10,0 HP	DİZEL	İPLİ/MARŞLI

	VİTES	GÜÇ AKTARIMI	ÇAPALAMA GENİŞLİĞİ	GİDON	BIÇAK SAYISI	AĞIRLIK	ÇAPALAMA DERİNLİĞİ
SEP 113	3 İLERİ - 1 GERİ	ŞANZIMAN	90 CM	AYARLI	24 ADET/6 SIRA	85 KG	30 CM
SEP 125	3 İLERİ - 1 GERİ	ŞANZIMAN	90 CM	AYARLI	24 ADET/6 SIRA	120 KG	30 CM

## SUPERSMART

ÜRÜN KODU: 490221

**2996 EUR**



## SUPERSMART

ÜRÜN KODU: 490120

**2996 EUR**



MOTOR	GÜÇ	YAKIT	ÇALIŞTIRMA
HONDA GX160	5,5 HP	BENZİN	İPLİ

MOTOR	GÜÇ	YAKIT	ÇALIŞTIRMA
HONDA GX160	5,5 HP	BENZİN	İPLİ

	VİTES	GÜÇ AKTARIMI	ÇAPALAMA GENİŞLİĞİ	GİDON	BIÇAK SAYISI	AĞIRLIK	ÇAPALAMA DERİNLİĞİ
ÇAYIR BIÇME	1 İLERİ - 1 GERİ	ŞANZIMAN	50 CM	AYARLI	16 ADET/4 SIRA	59 KG	30 CM
ÇAPALAMA	1 İLERİ - 1 GERİ	ŞANZIMAN	50 CM	AYARLI	16 ADET/4 SIRA	59 KG	30 CM

## MTC1000 2+2

ÜRÜN KODU: 490122

**3772 EUR**



## MTC1000 3+2

ÜRÜN KODU: 490123

**4735 EUR**



MOTOR	GÜÇ	YAKIT	ÇALIŞTIRMA
HONDA GX200	6,5 HP	BENZİN	İPLİ

MOTOR	GÜÇ	YAKIT	ÇALIŞTIRMA
KOHLER CH395	9,5 HP	BENZİN	İPLİ

	VİTES	GÜÇ AKTARIMI	ÇAPALAMA GENİŞLİĞİ	GİDON	BIÇAK SAYISI	AĞIRLIK	ÇAPALAMA DERİNLİĞİ
MTC1000 2+2	2 İLERİ - 2 GERİ	ŞANZIMAN	60/110 CM	AYARLI	20 ADET/6 SIRA	85 KG	30 CM
MTC1000 3+2	3 İLERİ - 2 GERİ	ŞANZIMAN	60/110 CM	AYARLI	20 ADET/6 SIRA	95 KG	30 CM

## MTC1900

ÜRÜN KODU: 490118

**6179 EUR**



## MTC4000

ÜRÜN KODU: 490119

**9357 EUR**



MOTOR	GÜÇ	YAKIT	ÇALIŞTIRMA
KAMA KD100	10 HP	DİZEL	İPLİ

MOTOR	GÜÇ	YAKIT	ÇALIŞTIRMA
LOMBARDİNI 3LD510	12,2 HP	DİZEL	İPLİ/MARŞLI

	VİTES	GÜÇ AKTARIMI	ÇAPALAMA GENİŞLİĞİ	GİDON	BIÇAK SAYISI	AĞIRLIK	ÇAPALAMA DERİNLİĞİ
MTC1900	3 İLERİ - 1 GERİ	ŞANZIMAN	75 CM	AYARLI	20 ADET/6 SIRA	200 KG	30 CM
MTC4000	4 İLERİ - 1 GERİ	ŞANZIMAN	75 CM	AYARLI	20 ADET/6 SIRA	200 KG	30 CM

## MFC 160



VİTES	GÜÇ AKTARIMI	KESME GENİŞLİĞİ	GİDON	AĞIRLIK
2 İLERİ - 2 GERİ	ŞANZIMAN	110/127 CM	AYARLI	57 KG

GX200			KD70			KD70 DİFRANSİYEL KİLİTLİ	
6,5 HP BENZİNLİ			6,7 HP DİZEL			6,7 HP DİZEL	
490233	490225	490226	490251	490227	490228	490229	490230
ESM	ZIPKALI	ZIPKALI	ESM	ZIPKALI	ZIPKALI	ZIPKALI	ZIPKALI
117 CM	110 CM	127 CM	117 CM	110 CM	127 CM	110 CM	127 CM
4773 EUR	4542 EUR	4636 EUR	4976 EUR	4751 EUR	4845 EUR	5270 EUR	5350 EUR

## MFC 186



VİTES	GÜÇ AKTARIMI	KESME GENİŞLİĞİ	GİDON	AĞIRLIK
3 İLERİ - 3 GERİ	ŞANZIMAN	110/127 CM	AYARLI	57 KG

GX270		KD70		KD70 DİFRANSİYEL KİLİTLİ	
9,0 HP BENZİNLİ		6,7 HP DİZEL		6,7 HP DİZEL	
490249	490250	490236	490237	490238	490239
ZIPKALI	ZIPKALI	ZIPKALI	ZIPKALI	ZIPKALI	ZIPKALI
110 CM	127 CM	110 CM	127 CM	110 CM	127 CM
6313 EUR	6393 EUR	5218 EUR	5314 EUR	6179 EUR	5710 EUR

## BC90



VİTES	GÜÇ AKTARIMI	KESME GENİŞLİĞİ	GİDON	DEBRİYAJ	AĞIRLIK
1 İLERİ - 1 GERİ	ŞANZIMAN	96 CM	AYARLI	KONİK DISK-KURU	70 KG

GX160	
5,5 HP BENZİN	
KOD	490245 490224
TİP	DÜZ ESM
BOYUT	90 CM 96 CM
FİYAT	2711 EUR 3785 EUR



## X-ROT

**YENİ**



## X-FLAIL

**YENİ**



KOD	MOTOR	GÜÇ	YAKIT	BIÇAK SAYISI	ÇALIŞMA GENİŞLİĞİ	ÇALIŞMA KAPASİTESİ	AĞIRLIK	
490290	XROT 95 EVO	FS730	26,0 HP	BENZİN	2 ADET DÜZ	95 CM	4000 M <sup>2</sup> / S	455 KG
490291	XROT 80 EVO	FS 481V	13,0 HP	BENZİN	2 ADET DÜZ	80 CM	3400 M <sup>2</sup> / S	380 KG
490292	XROT 70 EVO	B&S 3567	18,0 HP	BENZİN	2 ADET DÜZ	70 CM	3000 M <sup>2</sup> / S	370 KG
490293	XROT 70 EVO(E)	BHV 83973N	10,0 HP	ELEKTRİK	2 ADET DÜZ	70 CM	3000 M <sup>2</sup> / S	360 KG
490294	XFLAIL 80	B&S 3864	23,0 HP	BENZİN	40 ADET YAPRAK	80 CM	2800 M <sup>2</sup> / S	450 KG

## ROTEX 70

ÜRÜN KODU: 490246

**6420 EUR**



## G775

ÜRÜN KODU: 490247

**6741 EUR**



MOTOR	GÜÇ	YAKIT	ÇALIŞTIRMA
HONDA GXV390	10,2 HP	BENZİN	İPLİ

MOTOR	GÜÇ	YAKIT	ÇALIŞTIRMA
HONDA GX270	9,0 HP	BENZİN	İPLİ

	SİLİNDİR HACMİ	GÜÇ AKTARIMI	PARÇALAMA GENİŞLİĞİ	YÜKSEKLİK	DİFRANSİYEL	AĞIRLIK	YAKIT KAPASİTESİ
ROTEX 70	396 CC - 7,6KW	V KAYIŞ	70 CM	AYARLI	KİLİTLİ	120 KG	2,1 LT
G775	270 CC - 6,3 KW	V KAYIŞ	75 CM	AYARLI	KİLİTLİ	135 KG	5,3 LT

**ESM ADAPTÖR**

(SUPER SMART/BC90)

ÜRÜN KODU: 491650 **1284 EUR**

**YAĞ BANYOLU ADAPTÖR**

(MFC160/MFC186)

ÜRÜN KODU: 491654 **1097 EUR**



**ÇAPA APARATI**

(ŞUPERSMART)

ÜRÜN KODU: 491649 **958 EUR**



**ÇAYIR BİÇME APARATI**

(ŞUPER SMART/BC90)

ÜRÜN KODU: 491648 **958 EUR**



**DİZİLİ BIÇAK**

(BC90)

ÜRÜN KODU: 491660 **87 EUR** (90 CM)



**ZIPKALI KESİM GRUBU**

ÜRÜN KODU: 491655 **995 EUR** (110CM)

ÜRÜN KODU: 491656 **1070 EUR** (127 CM)



**KESİM GRUBU**

ÜRÜN KODU: 491658 **96 EUR** (110CM)

ÜRÜN KODU: 491659 **107 EUR** (127 CM)



**ESM KOMPLE BIÇAK**

ÜRÜN KODU: 491653 **910 EUR** (96 CM)

ÜRÜN KODU: 491657 **963 EUR** (117 CM)



**ESM DİZİLİ BIÇAK**

ÜRÜN KODU: 491651 **460 EUR** (96 CM)

ÜRÜN KODU: 491652 **471 EUR** (117 CM)





A person wearing a dark jacket with blue and white stripes on the sleeve is operating a motorized tillage implement in a field. The implement is primarily blue and silver, with the brand name 'FLASIH' visible on its side. The machine is actively tilling the soil, with a large amount of brown earth and some green weeds being thrown into the air. The background shows a clear blue sky and some trees. The brand name 'FLASIH' is overlaid in large, bold, blue letters across the center of the image, with a registered trademark symbol (®) to its upper right.

**FLASIH<sup>®</sup>**



# ÇAPALARIN GÜCÜ İLE TANIŞIN!

## FLASH 550

MOTOR	KOD	GÜÇ	YAKIT	ÇALIŞTIRMA
ANTOR 3LD510	590156	12,0 HP	DİZEL	MARŞLI
ANTOR 3LD510	590139	12,0 HP	DİZEL	GİDONSUZ/ÇAPASIZ-MARŞLI

FLASH	VİTES	GÜÇ AKTARIMI	ÇAPALAMA GENİŞLİĞİ	GİDON	BIÇAK SAYISI
FLASH 550	3 İLERİ - 1 GERİ	ŞANZIMANLI	120 CM + DİSKLER	AYARLI	32 ADET/8 SIRA



## FLASH 100



## FLASH 150



KOD	GÜÇ	YAKIT	ÇALIŞTIRMA
590111	6,5 HP	BENZİN	İPLİ

MOTOR	KOD	GÜÇ	YAKIT	ÇALIŞTIRMA
SR200	590114	6,5 HP	BENZİN	İPLİ

FLASH	VİTES	GÜÇ AKTARIMI	ÇAPALAMA GENİŞLİĞİ	GİDON	BIÇAK SAYISI	ÇAPALAMA DERİNLİĞİ
FLASH 100	1 İLERİ	KAYIŞLI KASNAKLI	45 - 63 CM	AYARLI	16 ADET/4 SIRA	30 CM
FLASH 150	1 İLERİ - 1 GERİ	KAYIŞLI KASNAKLI	90 CM + DİSKLER	AYARLI	24 ADET/6 SIRA	30 CM

## FLASH 250



## FLASH 300



KOD	GÜÇ	YAKIT	ÇALIŞTIRMA
590118	7,0 HP	BENZİN	İPLİ
590119	7,0 HP	BENZİN	İPLİ
590123	5,5 HP	DİZEL	İPLİ

MOTOR	KOD	GÜÇ	YAKIT	ÇALIŞTIRMA
SR210	590125	7,0 HP	BENZİN	İPLİ
B&S CR950	590126	7,0 HP	BENZİN	İPLİ
178F	590130	7,0 HP	DİZEL	İPLİ
178FE	590131	7,0 HP	DİZEL	İPLİ-MARŞLI

FLASH	VİTES	GÜÇ AKTARIMI	ÇAPALAMA GENİŞLİĞİ	GİDON	BIÇAK SAYISI	ÇAPALAMA DERİNLİĞİ
FLASH 250	2 İLERİ - 1 GERİ	ŞANZIMANLI	90 CM + DİSKLER	AYARLI	24 ADET/6 SIRA	30 CM
FLASH 300	3 İLERİ - 1 GERİ	ŞANZIMANLI	90 CM + DİSKLER	AYARLI	24 ADET/6 SIRA	30 CM

## FLASH 400



## FLASH 820



MOTOR	KOD	GÜÇ	YAKIT	ÇALIŞTIRMA
186F	590134	10,0 HP	DİZEL	İPLİ
186FE	590136	10,0 HP	DİZEL	İPLİ-MARŞLI

MOTOR	KOD	GÜÇ	YAKIT	ÇALIŞTIRMA
ANTOR 4LD820	590142	17,0 HP	DİZEL	MARŞLI
TDF292	590143	22,0 HP	DİZEL	MARŞLI

FLASH	VİTES	GÜÇ AKTARIMI	ÇAPALAMA GENİŞLİĞİ	GİDON	BIÇAK SAYISI	TEKERLEK BOYUTU
FLASH 400	3 İLERİ - 1 GERİ	ŞANZIMANLI	90 CM + DİSKLER	AYARLI	24 ADET/6 SIRA	-
FLASH 820	3 İLERİ - 1 GERİ	ŞANZIMANLI	120 CM + DİSKLER	AYARLI	32 ADET/8 SIRA	6,5/80-12

## FLASH 1007



## FLASH 1107



MOTOR	KOD	GÜÇ	YAKIT	ÇALIŞTIRMA
SR200	590157	6,5 HP	BENZİN	MARŞLI
B&S CR950	590158	7,0 HP	BENZİN	MARŞLI

MOTOR	KOD	GÜÇ	YAKIT	ÇALIŞTIRMA
B&S CR950	590159	7,0 HP	BENZİN	MARŞLI

FLASH	VİTES	GÜÇ AKTARIMI	ÇAPALAMA GENİŞLİĞİ	GİDON	BIÇAK SAYISI	TEKERLEK BOYUTU
FLASH 1007	1 İLERİ - 1 GERİ	ŞANZIMANLI	50 CM	AYARLI	20 ADET/6 SIRA	3,50 - 6
FLASH 1107	2 İLERİ - 2 GERİ	ŞANZIMANLI	60 CM	AYARLI	20 ADET/6 SIRA	4,00 - 10





## MİNİ RÖMORK

ÜRÜN KODU: 991683



## ÇAPA BIÇAĞI

ÜRÜN KODU: 991785	240 MM
ÜRÜN KODU: 991784	260 MM
ÜRÜN KODU: 991783	280 MM



## AKS DÜZ (27 MM)

ÜRÜN KODU: 991681



## DİSK FREN AMÖRTİSÖRLÜ

ÜRÜN KODU: 991685



## AKS KALIN FRENLİ (35 MM)

ÜRÜN KODU: 991696



## KARIK AÇMA&PULLUK

ÜRÜN KODU: 991678	Pulluk
ÜRÜN KODU: 991679	Karik Açma



## TEKERLEK&AKS TAKIMI (4,00-8)

ÜRÜN KODU: 991680



## AKS KİLİTLİ (27 MM)

ÜRÜN KODU: 991692



## AKS KALIN (35 MM)

ÜRÜN KODU: 991693



## AKS KALIN FRENLİ HALATLI (35 MM)

ÜRÜN KODU: 991695





**AKIN ZİRAAT**



**AKSESUARLAR  
& YEDEKPARÇA**





# KILAVUZLAR



ÜRÜN KODU	MALZEME KODU	ADIM (Inch)	KANAL GENİŞLİĞİ (inch-mm)	KILAVUZ BOYU (CM)	DİŞ SAYISI	FİYAT	UYUMLU MODELLER
816446	100SDEA041	91	.050"-1,3	25	20	9,80 USD	Oleo-Mac, GS260, Shindaiwa, 269 TS
816447	160SDEA074	91	.050"-1,3	41	27,5	9,80 USD	S 017, 018, 019, 021, MS170, MS180, MS181, MS210, MS211, MS192, MSE170, MSE190, MSEZIO, MSE230
816448	160SDEA095	91	.050"-1,3	41	28	9,50 USD	Husa 36, 41, EL 1400, 1600, 136, 141, Partner EL 1450, EL 1500, Castor C40, CP4, Dolmar PS410, PS411, ES1800
816449	160SDEA041	91	.050"-1,3	41	28,5	9,50 USD	Oleo-Mac, Efco, Alpina, Echo, Castor, Dolmar, McCulloch, Partne Poulan, Einhell, Bosch, Ikra, Makita, Ryobi
816450	160SXEA041	91	.050"-1,3	41	28,5	9,50 USD	Oleo-Mac, Efco, Alpina, Echo, Castor, Dolmar, McCulloch, Partne Poulan, Einhell, Bosch, Ikra, Makita, Ryobi
816451	160MLBK041	.325	.050"-1,3	41	33	10,40 USD	Oleo-Mac 941C, CX, GS470C, 940C, Dolmar PS420, Echo 420ES, Echo CS450, CS510 Echo CS450, CS510
816452	168PXBK095	.325	.058"-1,5	41	33	10,40 USD	Husa, Jonsered, Oleo-Mac, Efco, Alpina, Castor, Dolmar, Makita, McCulloch, Partner, Shindalwa, Solo
816453	183PXBA074	.325	.063"-1,6	46	34	11,40 USD	S MS230, MS231, MS250, MS251
816454	188SFHK095	3/8"	.058"-1,5	46	32	14,40 USD	Husa, Jonsered, Oleo-Mac GSH51, Efco, Alpina, Castor, Dolmar, Makita, McCulloch, Partner, Shindaiwa, Solo, Zomax
816455	188SFHD009	3/8"	.058"-1,5	46	34	14,10 USD	Husa 61, 268, 272, 281, 288, 365, 372XP, 385, 395XP, Jonsered 625, 630, 2077, 2065, 2166, 2171, 2172, Oleo-Mac GS650, Dolmar PS6400, PS7300, PS7900
816456	188PXBK095	.325	.058"-1,5	46	36	14,40 USD	Husa 55, 455, 359, 555, 560XP, Oleo-Mac GSH56, 956, 962, Dolmar TTI, 116, PS5105
816457	208SFHD009	3/8"	.058"-1,5	51	36	14,40 USD	Husa 61, 268, 272, 281, 288, 365, 372XP, 385, 395XP, Jonsered 625, 630, 2077, 2065, 2166, 2171, 2172, Oleo-Mac GS650, Dolmar PS6400, PS7300, PS7900
816458	203SFHD025	3/8"	.063"-1,6	51	36	14,40 USD	S 029, 034, 036, 038, 039, 044, 046, 064, 066, MS290, MS361, MS381, MS441, MS461, MS660
816459	DK25G30SLM	1/4"	.050"-1,3	25	30	18,50 USD	DAKKIN CS2500
816460	104MLAA041	1/4"	.050"-1,3	25	30	15,10 USD	DAKKIN CS2500D
816461	188SLHK095	3/8"	.058"-1,5	46	32	15,10 USD	Husa 55, 455, 359, 555, 560XP, Oleo-Mac GSH56, 956, 962
816462	DAKKIN-91-22	91	.050"-1,3	30	22	10,80 USD	DAKKIN CS2500
816463	DAKKIN-3/8-34	3/8"	.050"-1,3	46	34	12,80 USD	DAKKIN CS5460
816464	DKN-CSB0230213	1/4"	.050"-1,1	20	23,5	10,00 USD	DAKKIN CSB023



# & ZİNCİRLER

## KUTU ZİNCİRLER



ÜRÜN KODU	MALZEME KODU	ADIM(inch)	AYAK KALINLIĞI (inch-mm)	ZİNCİR TİPİ	DİŞ SAYISI	FİYAT
816333	91P055E	3/8"-91	.050"-1,3	Yuvarlak	27,5	12,50 USD
816334	91P056E	3/8"-91	.050"-1,3	Yuvarlak	28	12,70 USD
816335	91P057E	3/8"-91	.050"-1,3	Yuvarlak	28,5	13,00 USD
816336	95VPX066E	.325"	.050"-1,3	Yuvarlak	33	11,20 USD
816337	22BPX068E	.325"	.050"-1,3	Yuvarlak	34	13,40 USD
816338	20LPX072E	.325"	.058"-1,3	Köşeli	36	14,70 USD
816339	95VPX072E	.325"	.050"-1,3	Yuvarlak	36	13,70 USD
816340	20BPX072X	.325"	.058"-1,5	Yuvarlak	36	14,10 USD
816341	72LPX068	3/8"	.050"-1,3	Köşeli	34	15,90 USD
816342	72DX068E	3/8"	.058"-1,5	Yuvarlak	34	15,00 USD
816343	72DX072E	3/8"	.050"-1,3	Yuvarlak	36	15,90 USD
816344	72LPX072E	3/8"	.058"-1,5	Köşeli	36	16,30 USD
816345	73LPX072E	3/8"	.050"-1,3	Köşeli	36	17,40 USD
816346	DKN-1/4	1/4"	.058"-1,5	Yuvarlak	30	16,30 USD
816347	91P040E	3/8"-91	.050"-1,3	Yuvarlak	20	9,10 USD
816348	91P044E	3/8"-91	.050"-1,3	Yuvarlak	22	9,90 USD
816349	CSB0230214	1/4"	.050"-1,1	Yuvarlak	23,5	14,90 USD



## TOP ZİNCİRLER

816327	91VXL100R	.325"	.050"-1,3	Yuvarlak	36	258 USD
816328	20LPX100R	.325"	.058"-1,5	Köşeli	36	323 USD
816329	20BPX100R	3/8"	.050"-1,3	Yuvarlak	34	304 USD
816330	72LPX100R	3/8"	.058"-1,5	Köşeli	34	332 USD
816331	72DX100R	3/8"	.050"-1,3	Yuvarlak	36	304 USD
816332	73LPX100R	3/8"	.058"-1,5	Köşeli	36	349 USD



## ZİNCİR EKLERİ

816391	PERÇİN-001	3/8"-91	0,70 USD
816392	PERÇİN-002	.325	0,60 USD
816393	PERÇİN-003	3/8	0,70 USD



# MisinalAR



TİP	ÜRÜN KODU	KALINLIK	UZUNLUK	KOLİ ADEDİ	FİYAT
★	811528	3,0 mm	58 m	8	8,30 EUR
★	811529	3,3 mm	46 m	8	8,30 EUR
★	811530	3,5 mm	40 m	8	8,30 EUR



■	811531	3,0 mm	49 m	8	8,30 EUR
■	811532	3,3 mm	42 m	8	8,30 EUR
■	811533	3,5 mm	34 m	8	8,30 EUR



▲	811534	3,0 mm	63 m	8	8,30 EUR
▲	811535	3,3 mm	56 m	8	8,30 EUR



●	811537	3,0 mm	57 m	8	8,30 EUR
●	811538	3,3 mm	48 m	8	8,30 EUR



●	811539	2,0 mm	15 m	12	2,20 EUR
●	811540	1,7 mm	15 m	12	1,90 EUR
●	811541	1,3 mm	15 m	12	1,80 EUR



TİP	ÜRÜN KODU	KALINLIK	UZUNLUK	KOLİ ADEDİ	FİYAT
★	791513	3,0 mm	56 m	20	5,00 USD
★	791514	3,3 mm	46 m	20	5,00 USD
★	791515	3,5 mm	41 m	20	5,00 USD
★	791516	3,0 mm	1000 m	2	108,00 USD
★	791517	3,3 mm	1000 m	2	111,00 USD



■	791518	3,0 mm	51 m	20	5,00 USD
■	791519	3,3 mm	49 m	20	5,00 USD
■	791520	3,5 mm	42 m	20	5,00 USD
■	791521	4,0 mm	28 m	20	5,00 USD



▲	791522	3,0 mm	66 m	20	5,00 USD
▲	791523	3,3 mm	54 m	20	5,00 USD
▲	791534	3,0 mm	1000 m	2	108,00 USD



●	791528	3,0 mm	56 m	20	5,00 USD
●	791529	3,3 mm	46 m	20	5,00 USD
●	791524	4,0 mm	31 m	20	5,00 USD



●	791540	2,4 mm	87 m	20	5,00 USD
●	791539	2,7 mm	69 m	20	5,00 USD
●	791525	3,0 mm	1000m	2	108,00 USD
●	791538	3,3 mm	923m	2	108,00 USD



↻	791526	4,0 mm	28 m	20	13,00 USD
↻	791527	4,0 mm	110m	20	45,00 USD



▣	791530	3,0 mm	51 m	20	8,40 USD
↻	791531	3,3 mm	42 m	20	8,40 USD
↻	791532	3,3 mm	54 m	20	9,70 USD
○	791535	3,0 mm	35 m	20	10,50 USD



●	791533	1,3 mm	15 m	16	1,20 USD
●	791536	1,7 mm	15 m	16	1,30 USD
●	791537	2,0 mm	15 m	10	1,40 USD



## YAĞLAR



HACİM	ÜRÜN AÇIKLAMASI	ÜRÜN KODU	KOLİ ADEDİ	FIYAT
10 L	Motor Yağı	791413	1	67,00 USD
5 L	Motor Yağı	791412	3	36,00 USD
1 L	Motor Yağı - Ölçekli	791411	12	7,60 USD
1 L	Motor Yağı - Ölçekli - EUR5	791414	12	9,10 USD
1 L	Siver Motor Yağı - Ölçekli	811496	12	6,40 USD
1 L	Siver Motor Yağı - Ölçekli	811495	12	7,20 USD
120 MI	Motor Yağı	811494	81	1,30 USD
0,6 L	Motor Yağı	811499	20	5,30 USD
1 L	Zincir Yağı	811497	15	4,90 USD
3 L	Zincir Yağı	811498	8	10,20 USD
150 Gr	Tüp Gres	811492	100	2,20 USD
150 Gr	Tüp Gres	811414	110	2,30 USD
200 MI	Pas Sökücü Sprey	811415	30	2,30 USD

PowerG®

PowerG®

PowerG®

PowerG®



# AKSESUARLAR



ÖZELLİK	ÜRÜN KODU	FİYAT
Destekli	811620	1,90 USD
Anti Buğu	811621	3,00 USD
Standart	811622	1,70 USD
Ayarlı Siyah	811611	1,70 USD
Şeffaf	811612	1,90 USD

## GÖZLÜKLER



Standart - Camlı	811617	5,80 USD
Standart - Telli	811618	5,80 USD
Profesyonel - Ayarlı	811610	6,10 USD

## MASKELER



Standart	811619	4,20 USD
----------	--------	----------

## KULAKLIK



TİP	ÜRÜN AÇIKLAMASI	ÜRÜN KODU	FİYAT
ALÜMİNYUM ÜNİVERSAL	FLASH CUTTER BAŞLIK	961611	35,00 EUR
	40'LİK MİSİNA	961514	23,00 EUR

# BAŞLIKLAR



TİP	ÜRÜN AÇIKLAMASI	UYUMLU MODEL	ÜRÜN KODU	FİYAT
OTOMATİK	KURMALI M10x130mm	ÜNİVERSAL	981997	7,90 USD
ZİNCİRLİ	CANAVAR BAŞLIK	ÜNİVERSAL	981998	8,80 USD
ÖRÜMCEK	ÜSTTEN VİDALI	ÜNİVERSAL	981999	4,20 USD
MANTAR	ÜSTEN VİDALI	ÜNİVERSAL	991744	6,60 USD
FİLİZ ALMA	REDİKTÖRLÜ BÜYÜK	ÜNİVERSAL	991756	85,00 USD
HALI	YIKAMA FIRÇASI BÜYÜK	ÜNİVERSAL	991753	5,00 USD





TİP	ÜRÜN AÇIKLAMASI	ÜRÜN KODU	FİYAT
YAN	TIRPAN ASKISI	811625	27,00 USD

ÜRÜN AÇIKLAMASI	ÜRÜN KODU	FİYAT
 DAİRE TESTERE	991754	9,90 USD
 DAİRE TESTERE	991727	7,20 USD
 ÜÇLÜ BIÇAK 305*1.8*25.4	991761	5,80 USD
 İKİLİ BIÇAK 40CM	991745	6,90 USD
 DAİRE TESTERE	791720	8,80 USD
 ÜÇLÜ BIÇAK 255*1.4*25.4*3T	791721	4,90 USD
 İKİLİ BIÇAK 30CM	791722	5,90 USD



ÜRÜN AÇIKLAMASI	ÜRÜN KODU	FİYAT
BUJİ - İki zamanlı	991701	1,30 USD
BUJİ - Dört zamanlı	991702	1,30 USD



UYUMLU MODEL	ÜRÜN AÇIKLAMASI	ÜRÜN KODU	FİYAT
OLEOMAC	MAHLE HAVA FİLTRESİ	991730	3,00 EUR
STHIL	MAHLE HAVA FİLTRESİ	991706	3,00 EUR
STHIL	YERLİ HAVA FİLTRESİ	991752	1,20 EUR
HONDA	ÇİM BIÇME HAVA FİLTRESİ	991782	4,90 USD



UYUMLU MODEL	ÜRÜN AÇIKLAMASI	ÜRÜN KODU	FİYAT
MS250	MAHLE Piston Sekman Takımı 42,5 Mm	991703	32,00 EUR
MS361	MAHLE Piston Sekman Takımı 47 Mm	991704	48,00 EUR
MS380	MAHLE Piston Sekman Takımı 52 Mm	991705	55,00 EUR



TİP	ÜRÜN AÇIKLAMASI	ÜRÜN KODU	FİYAT
2,5 Mm	İp 100 M	991707	18,20 USD
3,0 Mm	İp 100 M	991708	18,20 USD
3,5 Mm	İp 100 M	991709	23,00 USD
4,0 Mm	İp 100 M	991710	26,00 USD
4,5 Mm	İp 100 M	991711	28,00 USD

KISAKOD	981994	KISAKOD	981755	KISAKOD	981753	KISAKOD	981748	KISAKOD	981744
FİYAT	0,30 USD	FİYAT	0,20 USD	FİYAT	0,30 USD	FİYAT	0,90 USD	FİYAT	0,50 USD
									
ACMA / KAPAMA DÜĞMESİ		AMORTİSÖR TAKOZU		AMORTİSÖR TAKOZU		AMORTİSÖR TAKOZU		AMORTİSÖR TAKOZU	
Tüm Modeller		CS5060,5200		CS5060,5200		Husq61,268,272		MS170,180	

KISAKOD	981745	KISAKOD	981989	KISAKOD	981747	KISAKOD	981750	KISAKOD	981752
FİYAT	0,80 USD	FİYAT	1,00 USD	FİYAT	2,30 USD	FİYAT	0,20 USD	FİYAT	0,50 USD
									
AMORTİSÖR TAKOZU		AMORTİSÖR TAKOZU		AMORTİSÖR TAKOZU		AMORTİSÖR YAYI		AMORTİSÖR YAYI BÜYÜK	
MS210,230,250,290,310,390		MS210,230,250,290,310,390		MS341,361		CS2500,3800,4500,5200,5800		CS4000,ZM4100	

KISAKOD	981742	KISAKOD	981743	KISAKOD	981751	KISAKOD	981754	KISAKOD	981746
FİYAT	0,60 USD	FİYAT	0,60 USD	FİYAT	2,10 USD	FİYAT	0,50 USD	FİYAT	1,80 USD
									
AMORTİSÖR YAYI		AMORTİSÖR YAYI		AMORTİSÖR YAYI		AMORTİSÖR YAYI KÜÇÜK		AMORTİSÖR YAYI	
Husq365,372		Husq365,372		Husq445,450		CS4000,ZM4100		MS341,361	

KISAKOD	981749	KISAKOD	981720	KISAKOD	981986	KISAKOD	981723	KISAKOD	981756
FİYAT	1,10 USD	FİYAT	3,80 USD	FİYAT	3,40 USD	FİYAT	6,00 USD	FİYAT	1,60 USD
									
AMORTİSÖR YAYI		BALATA		BALATA		BALATA		BALATA	
MS341,361		753,453,755		Tüm Modeller		Husq61		4500,5200,5800	

KISAKOD	981763	KISAKOD	981757	KISAKOD	981758	KISAKOD	981759	KISAKOD	981760
FİYAT	2,50 USD	FİYAT	2,50 USD	FİYAT	4,70 USD	FİYAT	5,30 USD	FİYAT	6,00 USD
									
BALATA		BALATA		BALATA		BALATA		BALATA	
CS2500-ZL2501		Husq137,142,236,P351		Husq340,345,350,445,450,455,460		Husq365,372		MS170	

KISAKOD	981761	KISAKOD	981762	KISAKOD	981764	KISAKOD	981766	KISAKOD	981765
FİYAT	4,50 USD	FİYAT	5,30 USD	FİYAT	3,90 USD	FİYAT	2,10 USD	FİYAT	6,30 USD
									
<b>BALATA</b>		<b>BALATA</b>		<b>BALATA</b>		<b>BALATA</b>		<b>BALATA</b>	
MS170,180,210,230,250		MS361,362,044,046,034,036		753T		CG520,BG520		FS120,200,250,400,450,480	

KISAKOD	981707	KISAKOD	981992	KISAKOD	981991	KISAKOD	981993	KISAKOD	981767
FİYAT	4,00 USD	FİYAT	4,70 USD	FİYAT	4,50 USD	FİYAT	2,70 USD	FİYAT	5,50 USD
									
<b>BALATA</b>		<b>BALATA TASI</b>		<b>BALATA TASI</b>		<b>BALATA TASI</b>		<b>BALATA YUVASI 28-9T</b>	
TJ53E		FR540/480		F5540/480		SP42/44 753		TJ53,CG630	

KISAKOD	981774	KISAKOD	981771	KISAKOD	981772	KISAKOD	981768	KISAKOD	981773
FİYAT	1,90 USD	FİYAT	0,80 USD	FİYAT	0,50 USD	FİYAT	0,30 USD	FİYAT	2,60 USD
									
<b>BENZİN DEPO KAPAĞI</b>		<b>BENZİN DEPO KAPAĞI</b>		<b>BENZİN DEPO KAPAĞI</b>		<b>BENZİN DEPO KAPAĞI</b>		<b>BENZİN DEPO KAPAĞI</b>	
753T		CG520,BG520		CS2500,ZL2501		CS5060,5200		FS400,450	

KISAKOD	981770	KISAKOD	981769	KISAKOD	981775	KISAKOD	981776	KISAKOD	981779
FİYAT	1,30 USD	FİYAT	0,80 USD	FİYAT	4,00 USD	FİYAT	4,00 USD	FİYAT	3,10 USD
									
<b>BENZİN DEPO KAPAĞI</b>		<b>BENZİN DEPO KAPAĞI</b>		<b>BENZİN DEPOSU KOMPLE</b>		<b>BENZİN DEPOSU KOMPLE</b>		<b>BENZİN DEPOSU KOMPLE</b>	
Husq365,37251,55		Husq61,268,272		BG520		BG520		CG520	





KISAKOD	981777	KISAKOD	981778	KISAKOD	981721	KISAKOD	981736	KISAKOD	981780
FİYAT	9,70 USD	FİYAT	8,00 USD	FİYAT	0,80 USD	FİYAT	0,90 USD	FİYAT	0,60 USD
									
<b>BENZİN DEPOSU KOMPLE</b>		<b>BENZİN DEPOSU KOMPLE</b>		<b>BENZİN FİLTRESİ MİNİ BEYAZ</b>		<b>BENZİN FİLTRESİ MİNİ SİYAH</b>		<b>BENZİN FİLTRESİ KEÇELİ</b>	
FS450,FR450		TJ53		GENEL TÜM MODELLER		GENEL TÜM MODELLER		GENEL TÜM MODELLER	



KISAKOD	981787	KISAKOD	981781	KISAKOD	981783	KISAKOD	981782	KISAKOD	981784
FİYAT	1,60 USD	FİYAT	0,50 USD	FİYAT	1,60 USD	FİYAT	0,80 USD	FİYAT	0,60 USD
									
BENZİN HORTUMU		BENZİN HORTUMU		BENZİN HORTUMU		BENZİN HORTUMU		BENZİN HORTUMU	
CS2500-ZL2501		CS5060,ZM5010		Husq 435,440,445,450		Husq 55,61,68,272,288,365		MS170,MS180	

KISAKOD	981786	KISAKOD	981785	KISAKOD	981788	KISAKOD	981790	KISAKOD	981789
FİYAT	0,70 USD	FİYAT	1,10 USD	FİYAT	0,70 USD	FİYAT	1,60 USD	FİYAT	0,90 USD
									
BENZİN HORTUMU		BENZİN HORTUMU		BENZİN POMPASI		BENZİN YAĞ DEPO KAPAĞI		BENZİN YAĞ DEPO KAPAĞI	
MS210,MS250,MS230		MS361,044,046		GENEL TÜM MODELLER		Husq 435,440,445,450		MS170,MS180	

KISAKOD	981792	KISAKOD	981793	KISAKOD	981791	KISAKOD	981794	KISAKOD	981797
FİYAT	0,60 USD	FİYAT	0,50 USD	FİYAT	0,70 USD	FİYAT	0,50 USD	FİYAT	0,50 USD
									
BUJİ KEPİ		BUJİ KEPİ		BUJİ KEPİ		CONTA TAKIMI		CONTA TAKIMI	
GENEL TÜM MODELLER		52CC TIRPAN GENEL MODELLER		TIRPAN GENEL TÜM MODELLER		4500,5200,5800		Husq235,236	

KISAKOD	981798	KISAKOD	981795	KISAKOD	981796	KISAKOD	981799	KISAKOD	981802
FİYAT	0,60 USD	FİYAT	1,00 USD	FİYAT	1,30 USD	FİYAT	1,00 USD	FİYAT	1,00 USD
									
CONTA TAKIMI		CONTA TAKIMI		CONTA TAKIMI		CONTA TAKIMI		CONTA TAKIMI	
Husq365,372		Husq51,55		Husq61,268,272		MS341,361		753T,755	

KISAKOD	981801	KISAKOD	981800	KISAKOD	981803	KISAKOD	981732	KISAKOD	981709
FİYAT	0,80 USD	FİYAT	0,90 USD	FİYAT	0,80 USD	FİYAT	26,00 USD	FİYAT	9,00 USD
									
CONTA TAKIMI		CONTA TAKIMI		CONTA VE KEÇE TAKIMI		DİŞLİ GRUBU KOMPLE Ø26 7T		DİŞLİ GRUBU KOMPLE Ø26 9T	
CG520,BG520		FS450,FR450		MS250		OM453		CG430	

KISAKOD	981738	KISAKOD	981706	KISAKOD	981729	KISAKOD	981804	KISAKOD	981717
FİYAT	9,00 USD	FİYAT	24,00 USD	FİYAT	25,00 USD	FİYAT	2,10 USD	FİYAT	4,20 USD
									
<b>DIŞLİ GRUBU KOMPLE Ø28 9T</b>		<b>DIŞLİ GRUBU KOMPLE Ø28 KARE</b>		<b>DIŞLİ GRUBU KOMPLE Ø32 10T</b>		<b>EGZOZ</b>		<b>EGZOZ</b>	
CG520		FS450		OM 753T,755M		TESTERE 4500,5200,5800		OM 753,453,755 EFCO 8530,8550	

KISAKOD	981811	KISAKOD	981813	KISAKOD	981806	KISAKOD	981807	KISAKOD	981805
FİYAT	2,60 USD	FİYAT	0,80 USD	FİYAT	4,00 USD	FİYAT	4,50 USD	FİYAT	4,30 USD
									
<b>EGZOZ</b>		<b>EGZOZ</b>		<b>EGZOZ</b>		<b>EGZOZ</b>		<b>EGZOZ</b>	
CS2500,ZL2501		Husq 51,55		Husq 365,372		Husq 435,440,445,450		Husq 51,55	

KISAKOD	981727	KISAKOD	981808	KISAKOD	981714	KISAKOD	981809	KISAKOD	981812
FİYAT	4,00 USD	FİYAT	5,20 USD	FİYAT	5,70 USD	FİYAT	7,40 USD	FİYAT	7,50 USD
									
<b>EGZOZ</b>		<b>EGZOZ</b>		<b>EGZOZ</b>		<b>EGZOZ</b>		<b>EGZOZ</b>	
Husq 61/268/272		MS170,MS180		MS250,025		MS341,MS361		TJ53	

KISAKOD	981810	KISAKOD	981815	KISAKOD	981822	KISAKOD	981821	KISAKOD	981814
FİYAT	3,90 USD	FİYAT	3,60 USD	FİYAT	16,40 USD	FİYAT	7,00 USD	FİYAT	7,20 USD
									
<b>EGZOZ</b>		<b>ELEKTRONİK BOBİN</b>		<b>ELEKTRONİK BOBİN</b>		<b>ELEKTRONİK BOBİN</b>		<b>ELEKTRONİK BOBİN</b>	
CG520 BG520		CS5060-ZM5010-5200		OM 753T		CG520,BG520		CS2500,ZL2501	

KISAKOD	981820	KISAKOD	981817	KISAKOD	981823	KISAKOD	981816	KISAKOD	981818
FİYAT	18,00 USD	FİYAT	10,10 USD	FİYAT	17,60 USD	FİYAT	12,50 USD	FİYAT	9,70 USD
									
<b>ELEKTRONİK BOBİN</b>		<b>ELEKTRONİK BOBİN</b>		<b>ELEKTRONİK BOBİN</b>		<b>ELEKTRONİK BOBİN</b>		<b>ELEKTRONİK BOBİN</b>	
FS400,450,480		Husq 365,372		Husq 445,450		Husq 50,51,55,61,268,272,272XP		MS230,MS250	

KISAKOD	981819	KISAKOD	981824	KISAKOD	981825	KISAKOD	981826	KISAKOD	981712
FİYAT	15,80 USD	FİYAT	19,50 USD	FİYAT	2,20 USD	FİYAT	1,90 USD	FİYAT	2,50 USD
									
<b>ELEKTRONİK BOBİN</b>		<b>ELEKTRONİK BOBİN</b>		<b>GAZ TELİ</b>		<b>GİDON KELEPÇESİ ALT ÜST 26MM-19MM</b>		<b>HAVA FİLTRESİ</b>	
MS361		TJ53		FS450		CG520		B&S 675EXI	

KISAKOD	981724	KISAKOD	981828	KISAKOD	981833	KISAKOD	981834	KISAKOD	981829
FİYAT	1,30 USD	FİYAT	1,60 USD	FİYAT	2,00 USD	FİYAT	2,00 USD	FİYAT	0,50 USD
									
<b>HAVA FİLTRESİ</b>		<b>HAVA FİLTRESİ</b>		<b>HAVA FİLTRESİ</b>		<b>HAVA FİLTRESİ</b>		<b>HAVA FİLTRESİ</b>	
CS4000,ZM4010,ZM4000		CG520,BG520		OM 937,941		OM 947,952		CS5060-ZM5010-5200	

KISAKOD	981837	KISAKOD	981831	KISAKOD	981836	KISAKOD	981830	KISAKOD	981835
FİYAT	0,80 USD	FİYAT	2,50 USD	FİYAT	2,30 USD	FİYAT	4,60 USD	FİYAT	1,00 USD
									
<b>HAVA FİLTRESİ</b>		<b>HAVA FİLTRESİ</b>		<b>HAVA FİLTRESİ</b>		<b>HAVA FİLTRESİ</b>		<b>HAVA FİLTRESİ</b>	
Husq 235,236,240		Husq 365,372		Husq 445,450		Husq 51,55		MS230,MS250	





KISAKOD	981832	KISAKOD	981839	KISAKOD	981840	KISAKOD	981841	KISAKOD	981842
FİYAT	4,90 USD	FİYAT	1,60 USD	FİYAT	0,20 USD	FİYAT	0,30 USD	FİYAT	0,50 USD
									
<b>HAVA FİLTRESİ</b>		<b>HAVA FİLTRESİ</b>		<b>HAVA FİLTRESİ</b>		<b>HAVA FİLTRESİ</b>		<b>HAVA FİLTRESİ</b>	
MS341,361		OM 753T,755		CG520,BG520,AG52		CG520,BG520,AG52		CG630,BG630,EFE	

KISAKOD	981838	KISAKOD	981843	KISAKOD	981844	KISAKOD	981847	KISAKOD	981845
FİYAT	1,60 USD	FİYAT	0,60 USD	FİYAT	0,90 USD	FİYAT	0,40 USD	FİYAT	0,30 USD
									
<b>HAVA FİLTRESİ</b>		<b>HAVA FİLTRESİ</b>		<b>HAVA FİLTRESİ</b>		<b>JİKLE KOLU</b>		<b>JİKLE KOLU</b>	
FS250,450,480		TJ53		MS170,180 Yeni Model		CS2500,ZL2500,ZL2501		CS5060-ZM5010-5200	



KISAKOD	981846	KISAKOD	981848	KISAKOD	981849	KISAKOD	981990	KISAKOD	981851
FİYAT	0,80 USD	FİYAT	0,60 USD	FİYAT	0,60 USD	FİYAT	2,60 USD	FİYAT	3,80 USD
									
JİKLE KOLU		JİKLE TELİ		JİKLE TELİ		KABZE KOMPLE		KABZE KOMPLE	
Husq 365,372		MS170,MS180		MS210,MS250,MS230		BG520		CG520	

KISAKOD	981850	KISAKOD	981867	KISAKOD	981711	KISAKOD	981996	KISAKOD	981995
FİYAT	8,40 USD	FİYAT	11,50 USD	FİYAT	7,90 USD	FİYAT	10,40 USD	FİYAT	12,10 USD
									
KABZE KOMPLE		KARBÜRATÖR		KARBÜRATÖR		KARBÜRATÖR		KARBÜRATÖR	
FS450		OM 753,453,755		GENEL ÇİN TIRPAN MODELLERİ		HONDA GX160,GX200		HONDA GX160,GX200	

KISAKOD	981702	KISAKOD	981861	KISAKOD	981859	KISAKOD	981860	KISAKOD	981863
FİYAT	14,90 USD	FİYAT	9,40 USD	FİYAT	16,60 USD	FİYAT	21,00 USD	FİYAT	12,30 USD
									
KARBÜRATÖR		KARBÜRATÖR		KARBÜRATÖR		KARBÜRATÖR		KARBÜRATÖR	
MS170,MS180		GENEL ÇİN TESTERE MODELLERİ		OM 941CX,GS35		OM 947,952		CS2500,ZL2501	

KISAKOD	981862	KISAKOD	981854	KISAKOD	981855	KISAKOD	981858	KISAKOD	981853
FİYAT	13,80 USD	FİYAT	17,30 USD	FİYAT	16,60 USD	FİYAT	19,30 USD	FİYAT	12,10 USD
									
KARBÜRATÖR		KARBÜRATÖR		KARBÜRATÖR		KARBÜRATÖR		KARBÜRATÖR	
ECHO CS510,CS520		Husq 236,240(Z)		Husq 365,372(Z)		Husq 445,450(Z)		Husq 51,55(W)	

KISAKOD	981852	KISAKOD	981856	KISAKOD	981857	KISAKOD	981864	KISAKOD	981866
FİYAT	18,70 USD	FİYAT	14,60 USD	FİYAT	32,00 USD	FİYAT	17,70 USD	FİYAT	29,00 USD
									
KARBÜRATÖR		KARBÜRATÖR		KARBÜRATÖR		KARBÜRATÖR		KARBÜRATÖR	
Husq 61,268,272(T)		MS230,250(Z)		MS361(Z)		FS400,450,480		Husq 553R	

KISAKOD	981865	KISAKOD	981868	KISAKOD	981870	KISAKOD	981869	KISAKOD	981871
FİYAT	23,00 USD	FİYAT	16,00 USD	FİYAT	49,00 USD	FİYAT	60,00 USD	FİYAT	21,00 USD
									
<b>KARBÜRATÖR</b>		<b>KARTER</b>		<b>KARTER</b>		<b>KARTER</b>		<b>KARTER</b>	
TJ53		GENEL ÇİN TESTERE MODELLERİ		Husq 365,372R		Husq 61,268,272		MS170,MS180	

KISAKOD	981872	KISAKOD	981873	KISAKOD	981875	KISAKOD	981876	KISAKOD	981874
FİYAT	29,00 USD	FİYAT	66,00 USD	FİYAT	26,00 USD	FİYAT	10,20 USD	FİYAT	24,00 USD
									
<b>KARTER</b>		<b>KARTER</b>		<b>KRANK</b>		<b>KRANK</b>		<b>KRANK</b>	
MS230,MS250		MS341,MS361		OM 746,756T		52CC GENEL(Tırpan,Burgu)		FS450,480	

KISAKOD	981710	KISAKOD	981877	KISAKOD	981878	KISAKOD	981879	KISAKOD	981880
FİYAT	13,30 USD	FİYAT	1,20 USD	FİYAT	0,80 USD	FİYAT	0,80 USD	FİYAT	2,70 USD
									
<b>KRANK</b>		<b>MANİFOLD</b>		<b>MANİFOLD</b>		<b>MANİFOLD</b>		<b>MANİFOLD</b>	
MS170		CS2500,ZL2501		Husq 365,372(R)		Husq 365,372(S)		Husq 445,450	

KISAKOD	981884	KISAKOD	981881	KISAKOD	981883	KISAKOD	981882	KISAKOD	981885
FİYAT	0,90 USD	FİYAT	0,80 USD	FİYAT	0,80 USD	FİYAT	1,10 USD	FİYAT	5,10 USD
									
<b>MANİFOLD</b>		<b>MANİFOLD</b>		<b>MANİFOLD</b>		<b>MANİFOLD</b>		<b>PİSTON KOMPLE 34MM</b>	
Husq 61		MS170,MS180		MS210,MS250,MS230		MS361		CS2500,ZL2500	

KISAKOD	981886	KISAKOD	981887	KISAKOD	981888	KISAKOD	981889	KISAKOD	981890
FİYAT	5,80 USD	FİYAT	5,60 USD	FİYAT	2,80 USD	FİYAT	7,20 USD	FİYAT	6,10 USD
									
<b>PİSTON KOMPLE 37MM</b>		<b>PİSTON KOMPLE 38MM</b>		<b>PİSTON KOMPLE 39MM</b>		<b>PİSTON KOMPLE 40MM</b>		<b>PİSTON KOMPLE 41MM</b>	
MS170,17		MS180,018		Husq 236,240		OM 941		CS4000,ZM4010	

KISAKOD	981891	KISAKOD	981892	KISAKOD	981893	KISAKOD	981895	KISAKOD	981894
FİYAT	5,80 USD	FİYAT	5,60 USD	FİYAT	5,60 USD	FİYAT	4,10 USD	FİYAT	7,40 USD
									
PİSTON KOMPLE 42,5MM		PİSTON KOMPLE 42MM		PİSTON KOMPLE 42MM		PİSTON KOMPLE 44MM		PİSTON KOMPLE 44MM	
MS250,025		FR450,FS450		Husq 445		ÇİN TIRPAN GENEL TÜM MODELLER		FS480,FR480	

KISAKOD	981896	KISAKOD	981898	KISAKOD	981897	KISAKOD	981899	KISAKOD	981900
FİYAT	6,10 USD	FİYAT	6,40 USD	FİYAT	5,80 USD	FİYAT	6,10 USD	FİYAT	7,20 USD
									
PİSTON KOMPLE 44MM		PİSTON KOMPLE 45MM		PİSTON KOMPLE 45MM		PİSTON KOMPLE 45MM		PİSTON KOMPLE 46MM	
TJ53		OM 753T		OM 952		CS5060,5200		Husq 55	

KISAKOD	981901	KISAKOD	981903	KISAKOD	981902	KISAKOD	981904	KISAKOD	981708
FİYAT	7,20 USD	FİYAT	6,50 USD	FİYAT	5,70 USD	FİYAT	7,90 USD	FİYAT	21,00 USD
									
PİSTON KOMPLE 47MM		PİSTON KOMPLE 48MM		PİSTON KOMPLE 48MM		PİSTON KOMPLE 49MM		SİLİNDİR KOMPLE	
MS361		Husq 365 (TEK SEKMAN)		Husq 61		MS390		OM 753,453,755	

KISAKOD	981735	KISAKOD	981905	KISAKOD	981741	KISAKOD	981733	KISAKOD	981703
FİYAT	15,90 USD	FİYAT	11,20 USD	FİYAT	11,20 USD	FİYAT	33,00 USD	FİYAT	33,00 USD
									
SİLİNDİR KOMPLE		SİLİNDİR KOMPLE		SİLİNDİR KOMPLE		SİLİNDİR KOMPLE		SİLİNDİR KOMPLE	
CS4000,ZM4010		CS5060,ZM5010		ÇİN GENEL TÜM MODELLER		FR450,FS450		FR480,FS480	

KISAKOD	981713	KISAKOD	981719	KISAKOD	981715	KISAKOD	981737	KISAKOD	981740
FİYAT	29,00 USD	FİYAT	19,50 USD	FİYAT	19,50 USD	FİYAT	14,40 USD	FİYAT	16,60 USD
									
SİLİNDİR KOMPLE		SİLİNDİR KOMPLE		SİLİNDİR KOMPLE		SİLİNDİR KOMPLE		SİLİNDİR KOMPLE	
Husq 445		Husq 55		Husq 61		MS170		MS250	



KISAKOD	981704	KISAKOD	981726	KISAKOD	981906	KISAKOD	981907	KISAKOD	981908
FİYAT	25,00 USD	FİYAT	40,00 USD	FİYAT	16,90 USD	FİYAT	14,40 USD	FİYAT	16,60 USD
									
SİLİNDİR KOMPLE		SİLİNDİR KOMPLE		SİLİNDİR+PİSTON 34MM		SİLİNDİR+PİSTON 38MM		SİLİNDİR+PİSTON 39MM	
MS361		TJ53		CS2500,ZL2500		MS180		Husq 236,240	

KISAKOD	981909	KISAKOD	981910	KISAKOD	981912	KISAKOD	981911	KISAKOD	981718
FİYAT	24,00 USD	FİYAT	24,00 USD	FİYAT	23,00 USD	FİYAT	21,00 USD	FİYAT	1,90 USD
									
SİLİNDİR+PİSTON 41MM		SİLİNDİR+PİSTON 45MM		SİLİNDİR+PİSTON 48MM		SİLİNDİR+PİSTON 48MM		SPİRAL MİL 79CM	
CS400,ZM4010		OM 952		CG630,BG630		Husq 365(S)		ÇİN TIRPAN MODELLERİ	

KISAKOD	981705	KISAKOD	981730	KISAKOD	981739	KISAKOD	981731	KISAKOD	981722
FİYAT	1,90 USD	FİYAT	1,90 USD	FİYAT	1,90 USD	FİYAT	8,10 USD	FİYAT	2,20 USD
									
SPİRAL MİL 84,4CM		SPİRAL MİL 89,5CM		SPİRAL MİL 94,6CM		STARTER		STARTER	
Husq TIRPAN MODELLERİ		FR450,480		OM-ERGO VE SPARTA		OM 753-755		ÇİN TIRPAN GENEL TÜM MODELLER	

KISAKOD	981914	KISAKOD	981701	KISAKOD	981923	KISAKOD	981917	KISAKOD	981918
FİYAT	3,80 USD	FİYAT	11,10 USD	FİYAT	9,40 USD	FİYAT	4,90 USD	FİYAT	8,20 USD
									
STARTER KOMPLE		STARTER KOMPLE		STARTER KOMPLE		STARTER KOMPLE		STARTER KOMPLE	
CS5060-ZM5010-5200		FR450,480,FS450,480		OM GS51,GSH51		Husq 236(E)		Husq 365,372	

KISAKOD	981919	KISAKOD	981915	KISAKOD	981916	KISAKOD	981920	KISAKOD	981921
FİYAT	6,80 USD	FİYAT	7,90 USD	FİYAT	8,40 USD	FİYAT	6,70 USD	FİYAT	6,60 USD
									
STARTER KOMPLE		STARTER KOMPLE		STARTER KOMPLE		STARTER KOMPLE		STARTER KOMPLE	
Husq 445,450(R)		Husq 51,55		Husq 61,268,272		MS170,180		MS230,250	

KISAKOD	981922	KISAKOD	981925	KISAKOD	981913	KISAKOD	981926	KISAKOD	981927
FİYAT	11,20 USD	FİYAT	6,60 USD	FİYAT	5,00 USD	FİYAT	5,00 USD	FİYAT	1,60 USD
									
STARTER KOMPLE		STARTER KOMPLE		STARTER KOMPLE		STARTER KURMALI MODEL		STARTER TIRNAK KOVANI	
MS361		TJ53 TJ53E		ZL2500		ÇİN TIRPAN GENEL TÜM MODELLER		OM 753T	

KISAKOD	981928	KISAKOD	981929	KISAKOD	981930	KISAKOD	981932	KISAKOD	981931
FİYAT	1,60 USD	FİYAT	4,30 USD	FİYAT	2,60 USD	FİYAT	4,60 USD	FİYAT	6,60 USD
									
STARTER TIRNAK KOVANI		ŞAFT MİLİ		TUTMA KOLU		TUTMA KOLU		TUTMA KOLU	
TJ53E		OM 753T		CS5060,5200		Husq 365,372		Husq 61,268,272	

KISAKOD	981933	KISAKOD	981934	KISAKOD	981827	KISAKOD	981941	KISAKOD	981935
FİYAT	8,90 USD	FİYAT	11,50 USD	FİYAT	7,10 USD	FİYAT	0,40 USD	FİYAT	1,30 USD
									
TUTMA KOLU		TUTMA KOLU		TUTMA KOLU		YAĞ DIŞLİSİ		YAĞ DIŞLİSİ	
MS170,180		MS230,250		MS341,361		CS5060-ZM5010-5200		CS4000,ZM4010	

KISAKOD	981940	KISAKOD	981937	KISAKOD	981936	KISAKOD	981938	KISAKOD	981939
FİYAT	1,00 USD	FİYAT	1,00 USD	FİYAT	0,70 USD	FİYAT	1,00 USD	FİYAT	2,60 USD
									
YAĞ DIŞLİSİ		YAĞ DIŞLİSİ		YAĞ DIŞLİSİ		YAĞ DIŞLİSİ		YAĞ DIŞLİSİ	
Husq 340,345,445,450		Husq 365,372(Yeni),575,570		Husq 61,268,272		MS 170,180,250,171,181,211		MS MS361,362,441,440,460,461,382(BR)	

KISAKOD	981947	KISAKOD	981942	KISAKOD	981943	KISAKOD	981946	KISAKOD	981949
FİYAT	2,60 USD	FİYAT	2,60 USD	FİYAT	3,10 USD	FİYAT	5,20 USD	FİYAT	4,10 USD
									
YAĞ POMPASI		YAĞ POMPASI		YAĞ POMPASI		YAĞ POMPASI		YAĞ POMPASI	
MS 170,180,250,171,181,211		CS2500 - ZM2501		CS5060-ZM5010-5200		Husq 340,345,135,435,440,445		Husq 365,372,385,390	

KISAKOD	981944	KISAKOD	981945	KISAKOD	981948	KISAKOD	981955	KISAKOD	981950
FİYAT	10,90 USD	FİYAT	11,50 USD	FİYAT	9,40 USD	FİYAT	5,00 USD	FİYAT	18,00 USD
									
<b>YAĞ POMPASI</b>		<b>YAĞ POMPASI</b>		<b>YAĞ POMPASI</b>		<b>YAN KAPAK FRENLİ</b>		<b>YAN KAPAK FRENLİ</b>	
Husq 51,55		Husq 61,268,272		MS361,362,460,441,461		CS5060-ZM5010-5200		Husq 51,55	

KISAKOD	981951	KISAKOD	981952	KISAKOD	981953	KISAKOD	981954	KISAKOD	981956
FİYAT	22,00 USD	FİYAT	9,20 USD	FİYAT	9,10 USD	FİYAT	3,30 USD	FİYAT	6,90 USD
									
<b>YAN KAPAK FRENLİ</b>		<b>YAN KAPAK</b>		<b>YAN KAPAK</b>		<b>YAN KAPAK</b>		<b>YAN KAPAK</b>	
Husq 61,268,272		Husq 236,240		Husq 365,372		MS170,180,230,250		MS361,362,441	

KISAKOD	981961	KISAKOD	981960	KISAKOD	981957	KISAKOD	981959	KISAKOD	981963
FİYAT	0,70 USD	FİYAT	1,30 USD	FİYAT	1,00 USD	FİYAT	1,40 USD	FİYAT	0,70 USD
									
<b>ZEMBEREK</b>		<b>ZEMBEREK</b>		<b>ZEMBEREK</b>		<b>ZEMBEREK</b>		<b>ZEMBEREK</b>	
CG520,BG520		FS250,450		Husq 365 372		Husq 61,268,272		CS5060,CS5200,CS5460	

KISAKOD	981964	KISAKOD	981958	KISAKOD	981962	KISAKOD	981965	KISAKOD	981966
FİYAT	0,90 USD	FİYAT	1,00 USD	FİYAT	1,30 USD	FİYAT	4,00 USD	FİYAT	2,80 USD
									
<b>ZEMBEREK</b>		<b>ZEMBEREK</b>		<b>ZEMBEREK</b>		<b>ZİNCİR DİŞLİSİ 3/25 7T</b>		<b>ZİNCİR DİŞLİSİ 3/25 7T</b>	
CS5060,CS5200,CS5460		MS180,230,250,290,360		MS361		Husq 340,350,345,445		ZM4010	

KISAKOD	981725	KISAKOD	981968	KISAKOD	981967	KISAKOD	981969	KISAKOD	981924
FİYAT	3,10 USD	FİYAT	5,10 USD	FİYAT	4,40 USD	FİYAT	4,70 USD	FİYAT	5,00 USD
									
<b>ZİNCİR DİŞLİSİ 3/25 7T</b>		<b>ZİNCİR DİŞLİSİ 3/25 7T</b>		<b>ZİNCİR DİŞLİSİ 3/25 7T</b>		<b>ZİNCİR DİŞLİSİ 3/25 7T</b>		<b>ZİNCİR DİŞLİSİ 3/25 7T</b>	
MS180,230,250,290,360		MS180,230,250,290,360		MS361		Husq 340,350,345,445		ZM4010	



KISAKOD	981971	KISAKOD	981972	KISAKOD	981973	KISAKOD	981974	KISAKOD	981970
FİYAT	3,20 USD	FİYAT	4,10 USD	FİYAT	4,40 USD	FİYAT	3,00 USD	FİYAT	3,60 USD
									
ZİNCİR DİŞLİSİ RULMANLI 3/8 6T		ZİNCİR DİŞLİSİ RULMANLI 3/8 7T		ZİNCİR DİŞLİSİ RULMANLI 3/8 7T		ZİNCİR DİŞLİSİ RULMANLI 91 6T		ZİNCİR DİŞLİSİ RULMANLI 91	
Husq 236		Husq 340,350,345,445		Husq 365,372		CS2500		ZM4010	

KISAKOD	981975	KISAKOD	981976	KISAKOD	981734	KISAKOD	981716	KISAKOD	981979
FİYAT	3,00 USD	FİYAT	3,70 USD	FİYAT	7,90 USD	FİYAT	3,00 USD	FİYAT	1,30 USD
									
ZİNCİR DİŞLİSİ RULMANLI		ZİNCİR DİŞLİSİ RULMANLI 13/25 7T		ZİNCİR DİŞLİSİ SABİT 3/8		ZİNCİR DİŞLİSİ SABİT 91		ZİNCİR GERME VİDASI	
MS180		CS4500,5200		Husq 61		MS170,180		CS2500	

KISAKOD	981977	KISAKOD	981980	KISAKOD	981982	KISAKOD	981983	KISAKOD	981978
FİYAT	1,70 USD	FİYAT	1,20 USD	FİYAT	0,70 USD	FİYAT	2,30 USD	FİYAT	2,70 USD
									
ZİNCİR GERME VİDASI		ZİNCİR GERME VİDASI		ZİNCİR GERME VİDASI		ZİNCİR GERME VİDASI		ZİNCİR GERME VİDASI	
CS4000,ZM4100		CS5060,5200		Husq 137,172,236,240		Husq 365,372		Husq 445,450	

KISAKOD	981981	KISAKOD	981985	KISAKOD	981984
FİYAT	1,00 USD	FİYAT	1,00 USD	FİYAT	3,20 USD
					
ZİNCİR GERME VİDASI		ZİNCİR GERME VİDASI		ZİNCİR GERME VİDASI	
Husq 61,268,272,288		MS170,MS180,MS250		MS361,MS380,MS381,MS382	

KISAKOD	991712	KISAKOD	991713	KISAKOD	991714	KISAKOD	991715	KISAKOD	991796
	FİYAT	4,60 USD	FİYAT	4,60 USD	FİYAT	10,50 USD	FİYAT	1,40 USD	
									
TETİKLİ İLAÇLAMA TABANCASI	AYARLI PÜSKÜRTME TABANCASI 60 CM	KABZE	PİSTON KOMPLE	KABZE					
İLAÇLAMA POMPALARI	İLAÇLAMA POMPALARI	NS16	NS16	İLAÇLAMA POMPALARI					

KISAKOD	991718	KISAKOD	991719	KISAKOD	991721	KISAKOD	991724	KISAKOD	991725
FİYAT	1,40 USD	FİYAT	0,60 USD	FİYAT	0,70 USD	FİYAT	1,70 USD	FİYAT	1,40 USD
									
PÜSKÜRTME UCU PLASTİK	KABZE TETİĞİ	PİSTON SIKMA VİDASI	HORTUM	SÜZGEÇ					
NS16	NS16	NS16	NS16	NS16					

KISAKOD	991726
FİYAT	8,90 USD
	
TABANCA BORUSU METAL	
NS16	

KISAKOD	991768	KISAKOD	991769	KISAKOD	991775	KISAKOD	991770	KISAKOD	991771
FİYAT	15,40 USD	FİYAT	67,00 USD	FİYAT	5,20 USD	FİYAT	9,10 USD	FİYAT	3,40 USD
									
<b>PULSATÖR (BEVİN)</b>		<b>KOMPLE MEMELİK</b>		<b>GÜĞÜM KAPAK CONTASI</b>		<b>MEMELİK LASTİĞİ</b>		<b>MEMELİK LASTİĞİ</b>	
SÜT SAĞIM		SÜT SAĞIM		SÜT SAĞIM		SÜT SAĞIM		SÜT SAĞIM	

KISAKOD	991772	KISAKOD	991773	KISAKOD	991774	KISAKOD	991776	KISAKOD	991777
FİYAT	13,60 USD					FİYAT	12,80 USD	FİYAT	19,60 USD
									
<b>SÜT HORTUMU</b>		<b>NABİZ HORTUMU</b>		<b>GÜĞÜM KAPAĞI</b>		<b>VAKUM METRE SAATİ</b>		<b>PENÇE</b>	
SÜT SAĞIM		SÜT SAĞIM		SÜT SAĞIM		SÜT SAĞIM		SÜT SAĞIM	

KISAKOD	991665	KISAKOD	991666	KISAKOD	991667
		FİYAT	29,00 USD		
					
<b>SULUK</b>		<b>SULUK</b>		<b>SULUK</b>	





KISAKOD	811704	KISAKOD	811705	KISAKOD	811706	KISAKOD	811732	KISAKOD	811701
FİYAT	1,40 USD	FİYAT	1,50 USD	FİYAT	0,80 USD	FİYAT	2,20 USD	FİYAT	68,00 USD
									
<b>KARBON ÇUBUK 5MM - 35CM</b>		<b>KARBON ÇUBUK 4,5MM - 35CM</b>		<b>PLASTİK ÇUBUK</b>		<b>KARBON ÇUBUK 5MM - 32,6CM</b>		<b>ŞANZİMAN KOMPLE</b>	
ZEYTİN HASAT		ZEYTİN HASAT		ZEYTİN HASAT		LİSAM ZEYTİN HASAT		ZEYTİN HASAT	

KISAKOD	811702	KISAKOD	811703	KISAKOD	811707	KISAKOD	811708	KISAKOD	811709
FİYAT	16,70 USD	FİYAT	2,00 USD	FİYAT	85,00 USD	FİYAT	56,00 USD	FİYAT	190,00 USD
									
<b>TARAK</b>		<b>GERGİ</b>		<b>MOTOR 750W</b>		<b>ELEKTRONİK KART 36V</b>		<b>KABLO 150MT</b>	
ZEYTİN HASAT		ZEYTİN HASAT		ZEYTİN HASAT		ZEYTİN HASAT		ZEYTİN HASAT	

KISAKOD	811710	KISAKOD	811711	KISAKOD	811712	KISAKOD	811713	KISAKOD	811714
FİYAT	7,90 USD	FİYAT	4,20 USD	FİYAT	10,60 USD	FİYAT	12,90 USD	FİYAT	8,70 USD
									
<b>BİYEL KOLU RULMANLI</b>		<b>SİGORTA YUVASI</b>		<b>KABZE KOMPLE</b>		<b>SOKET TAKIMI</b>		<b>KİLİTLEME KELEPÇESİ TAKIMI</b>	
ZEYTİN HASAT		ZEYTİN HASAT		ZEYTİN HASAT		ZEYTİN HASAT		ZEYTİN HASAT	

KISAKOD	811715	KISAKOD	811716	KISAKOD	811717	KISAKOD	811718	KISAKOD	811719
FİYAT	2,30 USD	FİYAT	18,90 USD	FİYAT	1,70 USD	FİYAT	23,00 USD	FİYAT	1,70 USD
									
<b>KİLİTLEME KELEPÇESİ MANDALLI</b>		<b>MOTOR KASASI ALT ÜST TAKIM</b>		<b>AÇMA KAPATMA DÜĞMESİ</b>		<b>İÇ DİŞ BORU</b>		<b>KABLO LASTİĞİ</b>	
ZEYTİN HASAT		ZEYTİN HASAT		ZEYTİN HASAT		ZEYTİN HASAT		ZEYTİN HASAT	

KISAKOD	811720	KISAKOD	811722	KISAKOD	811723	KISAKOD	811724	KISAKOD	811725
FİYAT	2,60 USD	FİYAT	27,00 USD	FİYAT	10,20 USD	FİYAT	1,70 USD	FİYAT	21,00 USD
									
<b>PİM CİVATA</b>		<b>BÜYÜK DİŞLİ</b>		<b>MİL DİŞLİ</b>		<b>YATAK SACI</b>		<b>SPIRAL KABLO</b>	
ZEYTİN HASAT		ZEYTİN HASAT		ZEYTİN HASAT		ZEYTİN HASAT		ZEYTİN HASAT	

KISAKOD	910370	KISAKOD	910373	KISAKOD	911482	KISAKOD	911483	KISAKOD	910352
FİYAT	13,80 USD	FİYAT	11,80 USD	FİYAT	102,00 USD	FİYAT	28,00 USD	FİYAT	85,00 USD
									
<b>AÇMA KAPAMA ANAHTARI</b>		<b>BATARYA AÇMA KAPATMA DÜĞMESİ</b>		<b>BATARYA BMS</b>		<b>BATARYA ÇANTASI</b>		<b>ŞARJ ALETİ</b>	
D30 ÇAY TOPLAMA MAKİNESİ		D30 ÇAY TOPLAMA MAKİNESİ		D30 ÇAY TOPLAMA MAKİNESİ		D30 ÇAY TOPLAMA MAKİNESİ		D30 ÇAY TOPLAMA MAKİNESİ	

KISAKOD	910374	KISAKOD	910369	KISAKOD	910360	KISAKOD	911484	KISAKOD	910362
FİYAT	37,00 USD	FİYAT	13,70 USD	FİYAT	72,00 USD	FİYAT	74,00 USD	FİYAT	1,30 USD
									
<b>AKÜ KABLOSU</b>		<b>SOKET</b>		<b>BIÇAK ALT ÜST TAKIM</b>		<b>BIÇAK ALT ÜST TAKIM YENİ MODEL</b>		<b>BIÇAK BURCU</b>	
D30 ÇAY TOPLAMA MAKİNESİ		D30 ÇAY TOPLAMA MAKİNESİ		D30 ÇAY TOPLAMA MAKİNESİ		D30 ÇAY TOPLAMA MAKİNESİ		D30 ÇAY TOPLAMA MAKİNESİ	

KISAKOD	910363	KISAKOD	910367	KISAKOD	910366	KISAKOD	911485	KISAKOD	910356
FİYAT	1,20 USD	FİYAT	0,90 USD	FİYAT	0,90 USD	FİYAT	12,80 USD	FİYAT	33,00 USD
									
<b>BIÇAK KEÇESİ</b>		<b>BIÇAK CİVATASI KISA</b>		<b>BIÇAK CİVATASI UZUN</b>		<b>BIÇAK DEMİRİ 5 CİVATALI</b>		<b>BIÇAK DIŞLİ YATAĞI 20MM</b>	
D30 ÇAY TOPLAMA MAKİNESİ		D30 ÇAY TOPLAMA MAKİNESİ		D30 ÇAY TOPLAMA MAKİNESİ		D30 ÇAY TOPLAMA MAKİNESİ		D30 ÇAY TOPLAMA MAKİNESİ	

KISAKOD	911486	KISAKOD	910357	KISAKOD	910358	KISAKOD	910359	KISAKOD	910368
FİYAT	33,00 USD	FİYAT	33,00 USD	FİYAT	11,20 USD	FİYAT	48,00 USD	FİYAT	85,00 USD
									
<b>BIÇAK DIŞLİ YATAĞI 22MM</b>		<b>BIÇAK DIŞLİ YATAK KAPAĞI</b>		<b>BIYEL KOLU</b>		<b>EKSANTRİK DIŞLİSİ</b>		<b>ELEKTRONİK KART</b>	
D30 ÇAY TOPLAMA MAKİNESİ		D30 ÇAY TOPLAMA MAKİNESİ		D30 ÇAY TOPLAMA MAKİNESİ		D30 ÇAY TOPLAMA MAKİNESİ		D30 ÇAY TOPLAMA MAKİNESİ	

KISAKOD	910364	KISAKOD	910372	KISAKOD	910361	KISAKOD	910365	KISAKOD	910371
FİYAT	27,00 USD	FİYAT	0,10 USD	FİYAT	0,10 USD	FİYAT	0,10 USD	FİYAT	1,30 USD
									
<b>GÖVDE KAPORTA SAĞ-SOL</b>		<b>KAPORTA ÜST CİVATASI</b>		<b>KAPORTA YAN CİVATASI</b>		<b>DIŞLİ KAPAK CİVATASI</b>		<b>YAĞ TAPASI</b>	
D30 ÇAY TOPLAMA MAKİNESİ		D30 ÇAY TOPLAMA MAKİNESİ		D30 ÇAY TOPLAMA MAKİNESİ		D30 ÇAY TOPLAMA MAKİNESİ		D30 ÇAY TOPLAMA MAKİNESİ	

KISAKOD	910355	KISAKOD	911487	KISAKOD	911488	KISAKOD	911489	KISAKOD	911491
FİYAT	108,00 USD	FİYAT	108,00 USD	FİYAT	7,50 USD	FİYAT	4,00 USD	FİYAT	5,75 USD
									
<b>MOTOR 20 MM</b>		<b>MOTOR 22 MM</b>		<b>MOTOR DİŞLİSİ</b>		<b>MOTOR ALT RULMANI</b>		<b>MOTOR ÜST RULMANI 18 MM</b>	
D30 ÇAY TOPLAMA MAKİNESİ		D30 ÇAY TOPLAMA MAKİNESİ		D30 ÇAY TOPLAMA MAKİNESİ		D30 ÇAY TOPLAMA MAKİNESİ		D30 ÇAY TOPLAMA MAKİNESİ	

KISAKOD	911490	KISAKOD	910375
FİYAT	7,85 USD	FİYAT	10,70 USD
			
<b>MOTOR ÜST RULMANI 20 MM</b>		<b>TOPLAMA KABI</b>	
D30 ÇAY TOPLAMA MAKİNESİ		D30 ÇAY TOPLAMA MAKİNESİ	

# MARKALARIMIZ



**DAKKIN**



**BAHCO**



**PowerG**® **FLASH**®



**PULMIC**®







# GÜÇ HER ZAMAN SİZİNLE



[b4b.akinziraat.com](http://b4b.akinziraat.com)



D100 Karayolu Üzeri D.S.İ. Yanı  
No:432 Merkez/ DÜZCE



444 5 204



YEDEKPARÇA / SATIŞ SONRASI  
0542 266 94 30 / 0541 341 40 68



[info@akinziraat.com](mailto:info@akinziraat.com)



[akinziraat](https://www.instagram.com/akinziraat)